

SAGOLA

an Elcometer company



**INDUSTRIAL PAINTING
PROFESSIONAL EQUIPMENT**





SAGOLA can trace its origins to the year 1955 and is fruit of the pioneering spirit of its founder, Alejandro Sánchez Larrauri.

It began as a small subcontracting workshop for industry. After some years in the subcontracting sector, Larrauri felt the need to manufacture his own product and progressively withdraw from subcontracted activity.

The chosen product was the spray gun. This new era for SAGOLA was crowned by the manufacture and sale of the mythical ALM 401 spray gun. From that very moment SAGOLA began to make and distribute a large number of spray gun models and other complements used in the coatings sector such as air filters, pressure pots, and an endless list of equipment for the most varied applications.

Due once again to the entrepreneurial spirit of the SAGOLA team, the need was felt to open the company to the international market. For that reason the Company began operating in related markets such as Latin America, where it soon became the indisputable leader, later expanding to Arab countries, Asia and finally Europe. Today, SAGOLA is present in more than 80 countries worldwide.

SAGOLA has maintained the highest quality standards in the manufacture of its products from its very beginnings, which has contributed to become a very important competitor in sectors such as bodyshop and industry.

In 2020, SAGOLA has become part of a much larger company. The ELCOMETER Group. Headquartered in the UK, Elcometer is also a family business and has been owned by the Sellars family for seven generations. Beginning in the 19th century as a chemical company, Elcometer, headquartered in Manchester, UK, has grown into one of the world's leaders in the design, manufacture and supply of equipment for the coating and non-destructive testing industries (END).

Elcometer exports more than 90% of the products it manufactures through its offices in France, Germany, Japan, the Netherlands, Singapore, the United Arab Emirates and the USA and its global distribution network that covers more than 170 countries throughout the world.

Like Sagola, the philosophy of the Elcometer company is to integrate quality into all aspects of the products they design and manufacture, while being very aware of the environment that surrounds us. Elcometer's commitment is reflected in its ISO 9001 and 14001 Quality and Environmental accreditations.

Main Index

Catalogue 2021

COMPANY
Page 5/10

**INDUSTRIAL AND
CONSTRUCTION
PUMPS**
Page 11/30

**INDUSTRIAL
PRESSURE POTS**
Page 31/38

**AEROGRAPHIC
SPRAY GUNS**
Page 39/46

**AUTOMATIC
SPRAY GUNS**
Page 47/54

**INDUSTRIAL AIR
FILTRATION
SYSTEMS**
Page 55/60

**COMPRESSED AIR
COMPLEMENTS**
Page 61/65

**GENERAL
APPLICATION
GUNS**
Page 66/68

SANDING SYSTEM
Page 69

**PERSONAL
PROTECTION & WASTE
MANAGEMENT SYSTEM**
Page 70/72

**GUIDES, SPARE PARTS
AND ACCESSORIES**
Page 73/83

[Background](#) | [Innovation](#) | [Services](#) | [Sectors](#) | [Customers](#) | [Standards](#) |

[Low pressure pumps](#) | [Pressure Spray guns](#) • [Low pressure pumps accessories](#) | [Pneumatic mix pump](#) | [Bellows pumps](#) |
[Mix Spray guns](#) • [Aircaps and accessories for mix spray guns](#) |
[Pneumatic airless pump](#) | [Electric airless pump](#) | [Airless Spray guns](#) • [Aircaps and accessories for airless spray guns](#) | [Industrial turbines](#) |

[Upper outlet pots](#) | [Lower outlet pots](#) |
[Hose for pressure pots](#) | [Pneumatic mixers](#) |
[Pumps and fluid supply system](#) | [Recipient lids](#) |

[X 4100 series Suction](#) | [3300 GTO Suction](#) | [Classic Pro Suction](#) |
[3300 New Press](#) | [X 4100 series Gravity](#) | [Mini Xtreme Gravity](#) |
[3300 GTO](#) | [Classic Pro XD Gravity](#) | [475 XTech](#) |

[V4](#) | [V5 HVLP](#) | [V6 EPA](#) | [V7/MIX](#) | [MiniV](#) |
[Versions and applications Serie V](#) | [450 A HVLP](#) | [4041A](#) | [4200 A EPA](#) | [4098](#) |
[4041 Mix](#) | [PSAA 108](#) |

[5000X range filters](#) | [4000 range filters](#) | [Plus range filters](#) |
[Air quality test equipment](#) | [Accessories and spare parts](#) |

[Quick couplings and connectors](#) | [Compressed Air Hoses](#) |

[Adhesives pressure](#) | [Classic S1 Blowguns](#) |
[Pneumatic undercoating guns](#) | [3900 Plus sealers](#) |

["L" range Sanders](#) | [Sander complements](#) |

[Face Mask 4240](#) | [MP300 Mask](#) | [FFP2 Masks](#) | [Classic MP2 Mask](#) |
[Antistatic Overall](#) | [Can Crushers](#) |

[Aircaps and accessories for airless/mix spray guns](#) |
[Filters and accessories. Pump maintenance](#) | [Spray gun accessories](#) |
[Spray gun aircaps](#) | [Nozzles and Needles for Spray Guns](#) |

Company

Since our beginnings, SAGOLA has always maintained the highest quality standards in its products and production processes, facilitating the most demanding coating processes.

SAGOLA began 65 years ago as a small subcontracting workshop with three workers. A strong desire to develop our own product and brand led SAGOLA to begin the manufacture of spray painting equipment.



Development and Innovation

Since our beginnings, SAGOLA has always maintained the highest quality standards in its products and production processes, facilitating the most demanding coating processes.



SAGOLA began 66 years ago as a small subcontracting workshop with three workers. A strong desire to develop our own product and brand led SAGOLA to begin the manufacture of spray painting equipment.

- > Achieve the best technical conditions in order to offer the highest quality in the finished product,
- > and at the same time present innovation in our most demanding markets, such as the bodyshop and industrial sectors,...

All of this has made SAGOLA what it is today, a company and a brand recognised not only in the domestic market, but in more than 80 countries worldwide.

**We have 65 years of experience
as manufacturer of spray guns
and spraying equipment**

After 65 years making and developing new products, we are convinced of the need to establish a close relation with our clients on a day-to-day basis.



We know that the best product is based on the proper development of what is demanded by the market at each moment in time. For that reason we constantly reinforce our training and sales and marketing personnel, which is in permanent contact with the market and its needs all over the world.

The quality of our products is acknowledged in more than eighty countries. SAGOLA has a vast experience and owns know-how in the manufacture of professional coating systems.

Human Resources

After many years of work SAGOLA can call upon an extensive team of experts who believe in quality and innovation. These two factors are and will continue to be the pillars on which our brand is built.



**Strengthening our human resources
is SAGOLA's principal objective**

SAGOLA is a worldwide benchmark brand thanks to the highly qualified professionals in our team. Notwithstanding, this team continues to work towards the objective of consolidating the SAGOLA brand as the industry yardstick.

**The high level of technology
in our production methods guarantees
the highest product quality standards**

The fusion of manufacturing, production means and manufacturing processes technologies with a highly qualified workforce has characterized SAGOLA from the very beginning.

R+D+i

Our commitment to R+D+i is absolutely clear. We devote all our efforts in this department to assuring that our products are adapted to the needs of the market.

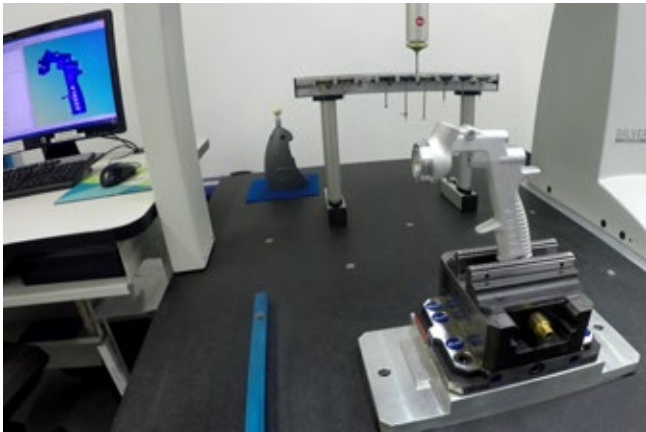

Our objective is that between both parties and the innovations generated at our headquarters, clients will regard SAGOLA as a safe bet and stay loyal to a brand which researches on a day-to-day basis to develop products which answer their needs.

Optimisation and Self-improvement and service

When it comes to service we are talking about a deeply rooted culture arising from the history of SAGOLA, to which service is vital.

The robotic automation of all our warehouses is an example, a major investment which gives us an advantage over the competition when it comes to offering a fast, reliable response which the market appreciates.



La Calidad como marca

If the SAGOLA brand plays an important role on the market after 66 years of history, this is due to the emphasis placed on QUALITY.



At our factory in Vitoria (Spain), each department you visit is steeped in an atmosphere of quality.

At the beginning the founder, Alejandro Sánchez, was able to transmit this vital concept and 66 years later his heritage on this point remains as vital as on the first day.



Warranty

SAGOLA provides a 3-year guarantee with the main products.



We know this is the best way of showing our customers that we believe in our products and that our guarantee will make our past and present customers loyal in the future



From its very beginnings SAGOLA has showed marked interest in advances related to care of and respect for the environment

Since the very first developments regarding VOC emissions to the atmosphere, SAGOLA wanted to be a cutting-edge company by implementing new environmental regulations and systems for its products.



With the inclusion of EPA and HVLP systems, as well as progress made in the field of filtration and others, we believe that we can contribute on a daily basis through new developments in our innovation policy.



Our commercial office and training team are amongst the pillars of the SAGOLA BRAND worldwide

Our training team and the entire company believes that there is an important difference between being merely a quality manufacturer and being a manufacturer which develops and trains workgroups for the various sectors in which we are present.



We believe that the products we make always need a solid sales support. Our commercial partners all over the world appreciate our assistance in setting up their sales networks and technical teams.

Thanks to the efforts of both, we embark upon each new financial year resting on a solid base suitable for the construction of a long-term project. Courses are available both at our Vitoria headquarters and on site.



This department is aware that our sales effort requires its support when responding to particular dilemmas, problems or needs related to specific queries we are constantly receiving from all over the world. These are transmitted rapidly to qualified experts who provide immediate data and solutions.

The sectors in which we have traditionally had a presence, have always considered us a leading brand, but to stay that way all the players in each sector demand that our developments take account of the changes taking place in each field. We therefore have different product lines for each segment in accordance with its needs.



Bodyshop

This is the sector most often identified with SAGOLA, and in many ways the sector which sets the standard for all the others as far as paints and performance are concerned.

Apart from our list of annexes, for this sector we detail our star products in quality and sales volume.



Industrial Vehicle

This sector recognises in SAGOLA an established manufacturer of coating spray guns and equipment. The brand is closely associated with reliability, quality and convenience at work, contributing confidence to the commercial vehicle distribution network.



Industrial Supplies

This is a constantly developing sector in which SAGOLA has always been the reference, with special finishes, equipment, for pressure and special pumps for products specifically developed for this sector.

**The loyalty of our users is one of our closest allies,
in conjunction with innovation**

Our business partners are aware that SAGOLA, as well as contributing a quality brand, provides them with a manufacturer who has won their loyalty by dint of constant effort over the years. This is something we strive for every day.

We are aware that our development and innovation will be our best allies along with the loyalty of our users in the future.

**SAGOLA has always been export-oriented and has
achieved a notable expansion**

We have always had an export-oriented attitude. We are currently present in more than 80 countries and keep on growing to ensure that our brand, and the products it represents, reach the entire world with the invaluable help and support of our importers.

More than 60 industrial patents/models registered worldwide CEE / ASIA / USA:

- Manual spray guns
- Automatic spray guns
- Packing nuts
- Blowguns
- Aircaps
- Valves
- Deposits
- Keys, Accessories



On the other hand the commitment to uphold the highest standards of security makes the manufacture of our products to evolution continuously in its design and manufacturing process. Therefore our standard products meet CE, ATEX, IP54, etc.

SAGOLA is a company which spends significant resources in R-D and is always in constant evolution. As result of this investigation and due to the need of protection of our own Know-how, SAGOLA is very active in all related with the intellectual property, being owner of a large number of patents worldwide.

Undoubtedly, SAGOLA is a recognized brand worldwide so in this aspect, the protection levels of our brand worldwide are very high. SAGOLA has got registered its different brands (SAGOLA, DEFYNIK and DELON) practically worldwide.



As a reference it is worth noting that SAGOLA was one of the first companies in Spain to obtain ISO certification, which meant a new management model where improvisation was forgotten and gave way to a management organization fully controlled and automated.

The commitment to the environment by SAGOLA has always been one of its main objectives. This is the reason why SAGOLA has been a pioneer in the manufacture of equipment for low-emission paint solvent to the atmosphere. We were pioneers in meeting environmental regulations as strict as the 1151 of the US California State SCAQMD.

Our relationship with painting manufacturers around the world means that launching SAGOLA in a new market is easier for us.

Our homologations make the market more active because users know that the product they are buying has been tested and homologated by their paint brand.

For many years, SAGOLA has devoted all its efforts not only on improving the quality of its products and service, but also to improve all aspects related with management, HR, environment, etc.

Industrial and Construction Pumps

Wide range of equipment for painting:

- > **Low Pressure Pumps** for spray guns.
- > **Airless Pumps** for airless spray gun operation.
 - > **Mix Pumps**
- > **Fluid supply of Liquids;** paints, solvents, oils...

Adapted to all industrial sector needs for spray painting:

- > **Mid to high continuous production** by automatic machinery and paint robots.
- > **Metal, wood, tannery, plastics, vehicles and industrial machinery sectors.**

Maximum resistance to all types of solvents and designed for the new waterborne paints and clearcoats.

The range of industrial pumps offered by SAGOLA adheres to our most demanding principles of quality in the materials employed and precision machining to produce technologically functional and robust pumps suitable for all types of paint.



INDUSTRIAL PAINTING
Industrial pumps
 Low pressure
 Pneumatics

DM 1/400



DM
1/400

High production

Several spray guns

Low pressure painting equipment

Twin Double Membrane Pump.

Painting equipment for high productions. It has been designed and manufactured focusing on the needs of several trades: from small metal, plastic and wood-working factories to the highest level industrial bodyshops.

It can be used with several spray guns at once.

Easy-to-use and low air-consumption combined with the highest performance.

Low maintenance cost.

There is a special version for abrasives.

Clearcoats, dyes, clears, ceramics, basecoats and glues. Basecoats, primers and, in general, medium viscosity products.

ATEX  II 2G x



***Full equipment (standard),** includes DM 1/400 (Trolley and absorption), 4100 X Series Pressure 1.20 [XT01 B] and 5 m. air and product hose (Ø 6mm. inside).

TECHNICAL DETAILS

- > Pressure ratio 1 : 1
- > Free flow: 40 L/min.
- > Product output pressure: max. 7 bar.
- > Air inlet pressure: max. 7 bar.
- > Air consumption: 580 L/min.
- > Weight: 18 kg.
- > Air inlet: BSP 1/4"
- > Product outlet: BSP 3/8"



Code	Version
30920401	Trolley and absorption
30920402	Trolley and deposit
30920403	Trolley and absorption (abrasives)
30920404	Trolley and absorption (Double outlet)
30920406	Wall and absorption
30920407	Wall and deposit
30920499	*Full equipment



DM 1/400 detail
 Double outlet product
 Code 30920404





DM 1/300 & DM 2K

DM
1/300

Medium production

High precision

ATEX II 2G x

30 L Double Membrane Pump.

Medium production. For finish and primers.

High precision product regulator.

Anti-pulsation system and double paint filter.
 Lacquers, clearcoats, basecoats, enamels.
 Medium viscosity products.



***Full equipment (standard),**
 includes DM 1/300 (Trolley and absorption),
 4100 X Series Pressure 1.20 [XT01 B] and
 5 m. air and product hose (Ø 6mm. inside).

TECHNICAL DETAILS

- > Pressure ratio 1 : 1
- > Free flow: 30 L/min
- > Air consumption: 380 L/min
- > Product output pressure: max: 6 bar
- > Air inlet pressure: max. 6 bar
- > Air inlet: BSP 1/4"
- > Product outlet: BSP 3/8"



Code	Version	Regulator
30920501	Trolley and Absorption	Included
30920502	Trolley and Absorption	-
30920503	Trolley and Deposit	Included
30920504	Trolley and Deposit	-
30920505	Wall and Absorption	Included
30920506	Wall and Absorption	-
30920507	Wall and Deposit	Included
30920508	Wall and Deposit	-
30920599	*Full equipment	Included

DM
2K

High production

Two-component

ATEX II 2G x

Double diaphragm pump for two components.
 Mixing ratio, 1:1

High production.

Prepared to work with medium viscosity
 products with solid particles.

Anti-pulsation system and double paint filter.
 Ideal for application of polyesters and acrylics.



Code Version

30920801	Trolley and Absorption
----------	------------------------

TECHNICAL DETAILS

- > Pressure ratio 1 : 1
- > Free flow: 40 L/min
- > Product output pressure: max: 7 bar
- > Air inlet pressure: max. 7 bar
- > Air consumption: 580 L/min
- > Weight: 21 kg



INDUSTRIAL PAINTING
 Industrial pumps
 Pressure
 spray guns

4100 X Series Pressure



Extensions
 See options in
 page 74

Forged and anodized aluminum body of great robustness and high corrosion protection

High strength and durability anodized aluminum air nozzles (corrosion free). Ideal for aggressive environments

High profitability in continuous painting. Time and tiredness saving

High durability self-adjusting gland

Capable to work with high paint flows

Maximum speed, productivity and ease of application

Air-paint single shaft

Sagola presents its new **X 4100 Series**, especially for the industrial painting sector. We maintain all the quality standards of its predecessor the 4100 and incorporate new aspects. All this makes it the perfect tool for work with very high demands in terms of quality of finish, robustness and ergonomics for continuous work.

Reduction of its dimensions to the maximum, thus improving the manageability and consequently the accessibility to the painting of parts with complex surfaces.

Adaptability perfect at hand, reducing the feeling of fatigue on continued work due to weight reduction and improvement in their support points.

It incorporates the air valve **SOFT FLOW**, higher precision and smoothness, even with high air pressure.

Application possibility for all kind of paints and sprayable products: dyes, metals, glazes, varnishes, basecoats, primers, glues, adhesives, abrasive products, ceramics, forge effect (special T.C.), textured, etc.

Trigger and shaft 100% made of stainless steel (Ultra-ergonomic design)

Reinforced stainless steel spool. Very high resistance against mechanical abrasion.

TECHNICAL DETAILS

- > Weight: 524 g
- > Dimensions: 18.2 x 17.2 x 4.2 cm
- > Air inlet coupling BSP 1/4" male
- > Product inlet coupling BSP 3/8" male
- > Design pressure: 8 bar
- > Maximum recommended inlet pressure (working pressure): 2.5- 3.0 bar (EPA & conventional)
- > Maximum recommended inlet pressure (working pressure): 2.0 bar (HVLV)
- > Maximum recommended application distance:
 EPA: 18 - 20 cm HVLV: 15 - 20 cm
 Conventional: 20 - 25 cm
- > Air consumption:
 765: 315 L/min XT01 B: 295 L/min
 777: 345 L/min XT03: 465 L/min
 20A: 430 L / min 3030: 514 L/min
- > Materials in contact with the product:
 INOX, chromed aluminium, POM,
 Teflon, Nylon.
- > ATEX II 2G x

- EPA System**
65% Transfer
XT01 B
Special automobile lines
- EPA System**
65% Transfer
Super VII
Special automobile lines
- HVLV System**
75% Transfer
XT03
Maximum saving
- HVLV System**
75% Transfer
3030
Minimum mist
- Medium Pressure**
55% Transfer
777
Max. spraying
- Medium Pressure**
55% Transfer
765 & 20A
Versatility

Code	Version	Application
10152408	1.00 [XT01 B]	Special metalized and basecoats
10152409	1.20 [XT01 B]	Clearcoats and primers
10152410	1.40 [XT01 B]	Primers and fillers
10152413	1.00 [Super VII]	Special metalized and basecoats
10152414	1.20 [Super VII]	Clearcoats and primers
10152416	1.40 [Super VII]	Primers and fillers
10152406	1.00 [XT03]	High quality finishes. Basecoats, dyes
10152407	1.20 [XT03]	General finishes. Primers
10152411	1.20 [3030]	Minimum mist. Industrial finishes
10152412	1.40 [3030]	Minimum mist. Primers, basecoats
10152404	1.00 [777]	Maximum speed
10152405	1.20 [777]	Finishes, high gloss
10152401	1.00 [765]	High quality finishes
10152402	1.20 [765]	General finishes. Primers
10152403	1.40 [765]	Primers, basecoats
10152417	1.80 [20 A]	Glues, adhesives

ASK FOR special nozzles up to 2.80 mm and Tungsten Carbide combinations



**4100 Xtreme Ceramic
and 4100 Xtreme PD**



4100
XTREME
CERAMIC

Nozzle and Needle in
Tungsten Carbide

Anodised aluminium aircaps
(corrosion free)

Trigger and axle made in
Stainless steel

Ideal for high microns jobs and
and highly abrasive products

High flow air valve "SOFT
FLOW" Ideal for work at high
pressures

TECHNICAL DETAILS

- > Weight: 552 g
- > Dimensions: 20 x 19 x 4.2 cm
- > Product inlet: 3/8" M BSP
- > Air inlet: 1/4" M BSP
- > Design pressure: 10 bar
- > Maximum recommended inlet pressure
(working pressure): 4 bar
- > Air consumption 1.4[78]/2.5[64]/2.8[62]: 410 L/min
Aircap 2.2[64]: 390 L/min 1.8[67]: 400 L/min
Aircap XT03: 460 L/min 2.8[63C]: 450 L/min
- > Materials in contact with product: Stainless Steel, POM,
Teflón, Nylon and Tungsten Carbide.
- > ATEX II 2G x



Applications: Toiletes, Roof tiles, Kitchen
equipment, Plates, Tiles, Engobe, Ceramic
enamels, Vitrified enamels, Structural
anticorrosive treatment, etc.



Ideal for marking paints, road markings, primers,
high thickness, waterproofing, intumescent, soil
protection, generally dense products,...

TECHNICAL DETAILS

- > Weight: 552 g
- > Dimensions: 20 x 19 x 4.2 cm
- > Product inlet: 3/4" M BSP
- > Air inlet: 1/4" M BSP
- > Design pressure: 8 bar
- > Maximum recommended inlet pressure
(working pressure): 3 bar
- > Air consumption (2 bar inlet): 147 L/min
- > Average sound pressure level: 80 dB
- > Materials in contact with product:
INOX, POM, Teflon and Nylon.
- > ATEX II 2G x



Code	Version
10152130	1.4 [78]
10152131	1.4 [XT03]
10152132	1.8 [67]
10152133	2.2 [64]
10152134	2.5 [64]
10152135	2.8 [62]
10152136	2.8 [63C]

A perfect fusion between speed and high transfer
with quality finishes of XTREME aerographic
systems.

In the ceramic applications, we provide the
maximum resistance. And in vitroceramic, we
can achieve the highest degree of refinement and
finishing quality.

4100
XTREME PD

Speed of application and
high transfer level (>80%)

XTREME Finish quality

Robustness

**Maximum quality of
materials**

Ideal for difficult jobs

Easy and smooth to use

Code	Version
10152301	6.0 [PD1]
20530705	*Full equipment

***Full equipment**, includes Classic 30
Inox pressure pot, 4100 Xtreme PD and
10 m. air and product hose.



Forged and anodized body, providing great
strength and protection to corrosion both externally
and internally.

Nozzles with Internal mixing XTREME technology.
Perfect atomization. METAL TO METAL technology
where all sealings are free of joints.



INDUSTRIAL PAINTING
Industrial pumps
Pressure
spray guns

Mini Xtreme Pressure and 3300 GTO Pressure



High resistance polishing
and anodizing

Specially recommended for
dyes and metalics

Ideal for line-painting

Top quality finishes

Manufactured in
forged aluminium

Perfect ergonomics

SAGOLA Xtreme system
with compact size



Extensions

See options in
page 74



High precision air-flow
regulator included
Solvent-proof gaskets



Due to its size it is the
perfect spray gun
for **restricted access areas** which
require a lot of wrist movement.
It reduces mist, saves paint and
perfectly **defines the work zone.**

Adapted to the latest products. Tested
and developed with waterborne
products.

Its new MiniVIT aircap offers a high speed
application with a large fan. Designed to work at
the highest degree of atomisation at low pressures.

Code	Version	Application
10111907	1.00 [Mini VIT]	Dyes and metals
10111908	1.20 [Mini VIT]	Highest quality finishes
10111909	1.40 [Mini VIT]	Primers, basecoats and fillers
10111904	0.80 [Mini EPA]	Feathering, dyes, basecoats
10111905	1.00 [Mini EPA]	Highest quality finishes
10111906	1.20 [Mini EPA]	Very high speed finishes
10111901	0.80 [Mini HVLP]	Especially for dyes
10111902	1.00 [Mini HVLP]	Finishes, low mist
10111903	1.20 [Mini HVLP]	Finishes, primers



There are no gaskets in couplings
between air and paint
Designed without O-rings
in the air system

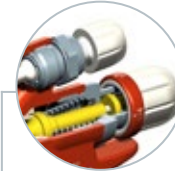

Product and fan pattern regulators
High precision aluminium regulators
designed for easy handling even
when wearing gloves.

Numbered product regulator
For totally accurate paint control.

TECHNICAL DETAILS

- > Weight: 347 g
- > Air inlet coupling thread BSP 1/4" male
- > Paint inlet coupling thread BSP 3/8" male
- > Maximum air pressure: 8 bar
- > Maximum recommended application distance:
Mini EPA: 15 - 18 cm
Mini HVLP: 10 -15 cm
Mini VIT: 18 cm
- > Maximum air consumption:
Mini EPA: 190 L/min
Mini HVLP: 335 L/min
Mini VIT: 375 L/min
- > Materials in contact with the product:
INOX, chromed aluminium, POM,
Teflon, Nylon
- > ATEX II 2G x



3300
GTO



New design
New forged and chrome body

High performance and
atomization

High transfer aluminium
aircaps

Light and robust

Versatile

With a light injected-aluminium
body, it is a top level product with
an excellent price/quality ratio.
High performance. High speed
application. Large size fan.
Application of enamels, varnishes,
primers and basecoats. Nozzles
and needles in stainless steel. HVLP and EPA
aircaps that comply with regulations concerning
solvent emissions.

Code	Version	Application
10152210	1.00 [HVLP]	Finishes, Dyes
10152211	1.20 [HVLP]	General finishes
10152212	1.40 [HVLP]	Primers, basecoats
10152214	1.00 [EPA]	Top quality finishes
10152215	1.20 [EPA]	General finishes
10152216	1.40 [EPA]	Primers

ASK for special nozzles

TECHNICAL DETAILS

- > Weight: 478 g
- > Dimensions: 18 x 17.5 x 4 cm
- > Product inlet: 3/8" M BSP
- > Air inlet: 1/4" M BSP
- > Air consumption (2 bar inlet):
GTO EPA: 240 L/min
GTO HVLP: 360 L/min
- > ATEX II 2G x





Filter accessories pump anti-recoil

Code	Description
83660029	100-mesh DM 400 filter
83660030	60-mesh DM 400 filter

Product regulator low pressure

Code	Description
52410019	Product regulator low pressure / DM

Accessories

Code	Description
30090017	Membrane kit - DM 400
30090018	Air distribution centre gasket kit DM 400
30090019	Pneumatic distribution kit DM 400
30090020	Product valve kit DM 400



Absorption filters

Code	Description
56418055	40 microns circular filter + spring
83660047	Special absorption filter for narrow pass

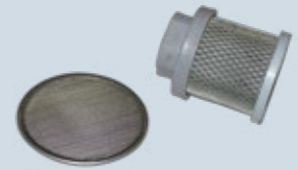

Turbines filters

Code	Description
56418597	Air filter Kit Turbo 3000 Pro (6 units)
56418663	Air filter Kit Turbo 2200 Pro (6 units)



Air hose. Anti-static

Code	Description
56414014	2.5 m. 6x12mm F 1/4" - F 1/4"
56414024	6 m. 8x15mm F/F 1/4"
56414025	11 m. 8x15mm F/F 1/4"
56414027	16 m. 8x15mm F/F 1/4"
56414026	26 m. 8x15mm F/F 1/4"

Air + Product hoses. Aerographics

Code	Description
86463818	5 m. spray gun hose set (8 mm. + 6 mm.) HVLP
86463819	10 m. spray gun hose set (8 mm. + 6 mm.)
86463891	Adhesives. 10 m. air hose 8 mm. + 10 mm. Product hose
86463894	Dyes. 5 m. air hose 8 mm. + 3 mm. Product hose



Product hose. Anti-static

Anti-static aerographic hose for Waterborne/Solvent. 8x16 mm. F/F 3/8"

Code	Description
56414116	6 m. Product hose 8x16mm. F-F 3/8"
56414117	11 m. Product hose 8x16mm. F-F 3/8"
56414115	16 m. Product hose 8x16mm. F-F 3/8"

Air hose + product hose + cover. Aerographics.

Lights. Anti-static Air hose. 8x15 mm. Product hose with 3/8" adapter

Code	Description
56414039	5 m. (Air hose 8x15 mm. + product hose 6x8 mm. + cover)
56414044	7.5 m. (Air hose 8x15 mm. + product hose 6x8 mm. + cover)
56414040	10 m. (Air hose 8x15 mm. + product hose 6x8 mm. + cover)
56414041	15 m. (Air hose 8x15 mm. + product hose 6x8 mm. + cover)
56414042	20 m. (Air hose 8x15 mm. + product hose 6x8 mm. + cover)



INDUSTRIAL PAINTING
Industrial pumps
Pneumatic
Mix pump

Raider 300 Mix



Raider 300 mix
 (Trolley and deposit
 version)



***Full equipment (standard),**
 includes Raider 300 mix (Trolley and absorption), Mini
 Xtreme Mix, 5 m. product and air hoses.

RAIDER
300mix

High Production

Easy to use

Very low air consumption

Minimum maintenance

ATEX II 2G x

SAGOLA introduces its new range of professional line RAIDER 300 MIXED version.

This line, exclusively designed and manufactured for professional use, gathers high standards both in term of performance and image.

Within the quality standards we focus on simplicity and durability.

Thus, we have redesigned completely the hydraulics. Now it contributes to a long-lasting life even in the worst working conditions and without waiving on its performance.

Code	Version
30951602	Trolley and absorption
30951603	Trolley and deposit
30951604	Wall and deposit
30951605	Wall and absorption
30951698	*Full equipment

TECHNICAL DETAILS

- > Pressure ratio: 30:1
- > Product inlet: Ø 12 x 21 mm.
- > Product outlet: BSP 1/4"
- > Free flow (60 cycles): 1.8 L/min
- > Product output pressure: max.: 200 bar
- > Air inlet pressure max.: 7 bar
- > Max. air consumption: 370 L/min
- > Tip max: 0.013"
- > Weight: 15.5 kg



Applications

Ideal for clearcoats, waterborne products, lacques, fonds, enamels and light primers.

The mixed version raider range has been designed and manufactured focusing on the needs of medium metal and wood-working factories.

Mack 150 Mix and Mack 320 Mix

MACK 150mix

High Production

ATEX  II 2G x



Mack 150 mix
(Trolley and deposit
version)

Mix pump. Ideal for finishes in high production, easy to use and very robust.

Reduced maintenance and self-adjusting packing system.

Clearcoats and waterborne paints, lacquers, basecoats and primers, enamels and antioxidants.

Code	Version
30931901	Trolley and absorption
30931902	Trolley and deposit
30931903	Wall and absorption
30931904	Wall and deposit
30931999	*Full equipment

TECHNICAL DETAILS

- > Pressure ratio: 15:1
- > Free flow (60 cycles): 2.7 L/min
- > Product output pressure: max.: 91 bar
- > Air inlet pressure max.: 7 bar
- > Air consumption: 245 L/min
- > Tip max: 0.018"
- > Weight: 20 kg



***Full equipment (standard),**
 includes Mack 150 mix (Trolley and absorption), Mini Xtreme Mix, 5 m. product and air hoses.

More information and application guides on page 82-83

MACK 320mix

High Production

ATEX  II 2G x



Pneumatic mix pump for high speed and production. Easy to use and high robust. Reduced maintenance and self-adjusting packing system.

Clearcoats and waterbase products, lacquers, fillers, primers and anti-oxidant products.

Code	Version
30932003	Trolley and absorption
30932004	Trolley and deposit
30932006	Wall and absorption
30932009	Wall and deposit
30932099	*Full equipment

TECHNICAL DETAILS

- > Pressure ratio: 32:1
- > Free flow (60 cycles): 2.7 L/min
- > Product output pressure: max.: 226 bar
- > Air inlet pressure max.: 7 bar
- > Air consumption: 610 L/min
- > Tip max: 0.018"
- > Weight: 20 kg



***Full equipment (standard),**
 includes Mack 320 mix (Trolley and absorption), Mini Xtreme Mix, 5 m. product and air hoses.

More information and application guides on page 82-83

INDUSTRIAL PAINTING

Industrial pumps

Mix

Bellows pumps

HTV 250

High production

Minimum maintenance

Bellow pump system (without packing-gland)

Easy to use

Very low air consumption

Ideal for the medium metal and wood working factories

ATEX  II 2G x

Code	Version
30931801	Trolley and absorption
30931899	*Full equipment

***Full equipment (standard),** includes HTV250, Mini Xtreme Mix and 7 m. product and air hoses.

More information and application guides on page 82-83

HT

Recommended for automatic paint lines

Continuous production

Ideal for UV products

ATEX  II 2G x

Code	HT10
30951901	Trolley and absorption
30951902	Wall and absorption
30951999	*Full equipment

Code	HT15
30952001	Trolley and absorption
30952002	Wall and absorption
30952099	*Full equipment

Code	HT25
30952301	Trolley and absorption
30952302	Wall and absorption
30952399	*Full equipment

HTV 250 and HT 10/15/25

Sagola new professional range of vertical bellows pumps; HTV 250 mixed version.

Designed and manufactured for professional use, the HTV 250 offers excellent performance both in terms of features and design. The hydraulic components were redesigned for highest level of quality focused on technology and durability.

Thus, we have redesigned completely the hydraulics. Now it contributes to a long-lasting life even in the worst working conditions and without waiving on its performance. The bellows system provides long-lasting durability with minimum maintenance even for highly demanding materials.

TECHNICAL DETAILS

- > Pressure ratio: 25:1
- > Free flow (60 cycles): 2.8 L/min
- > Product output pressure max.: 175 bar
- > Air inlet pressure max.: 7 bar
- > Air consumption: 448 L/min
- > Maximum Tip: 0.018"
- > Weight: 30 kg



HT 10/15/25

Pneumatic mix pump ideal for automatic installations. High flow bellows pump without pressure drops. With its oversized design offers a very long life and minimum maintenance. Suitable for several manual spray guns.

Lacquers, fillers, primers, enamels, clearcoats, ultraviolet and polycyclic. Generally, medium viscosity products.

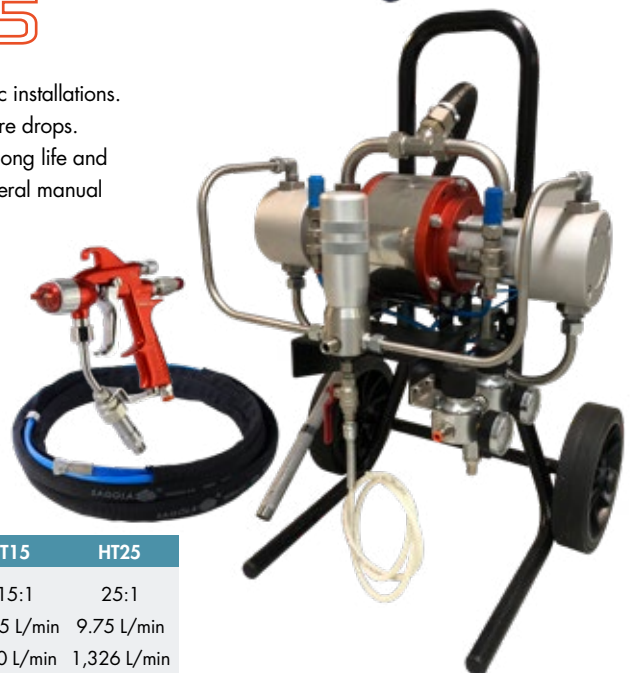

TECHNICAL DETAILS

	HT10	HT15	HT25
> Pressure ratio:	10:1	15:1	25:1
> Free flow:	9.75 L/min	9.75 L/min	9.75 L/min
> Air consumption:	646 L/min	800 L/min	1,326 L/min
> Product output pressure max.:	60 bar	90 bar	150 bar
> Air inlet pressure max.:	6 bar	6 bar	6 bar
> Weight:	41 kg	42 kg	48 kg

***Full equipment (standard),** includes HT10/15/25 (trolley and absorption), Mini Xtreme Mix and 5 m. product and air hoses.

Recommended spray guns: V7, 4041 Mix and Xtreme Mix



Mini Xtreme Mix



Fluid filter housing
 guarantying coating quality

Swivel coupling
 avoiding tension in the fluid hose

Mini
XTREME MIX

High resistance and anodized forged aluminium body

Nozzle and Needle fittings made of Tungsten carbide

Smooth action trigger 100% Stainless steel

Exterior and interior corrosive protection

Ideal for complex jobs

Maximum ergonomics

ATEX  II 2G x

SAGOLA presents its new spray gun where is the result of a great design work, obtaining one of the smaller and ergonomics mixed gun on the market. Ideal for painting parts with complex shapes.

A perfect fusion between speed and high transfer with quality finishes of XTREME aerographic systems.

Full control in the regulation of fan, maximum precision.

Ideal for waterborne products. Designed for UV and waterborne paints. Ideal for furniture sector, industry and industrial bodyshop.

XTREME technology nozzles

METAL TO METAL technology, free of joints



Progressive air valve
 Better control and precision

Tool-less needle disassembling system

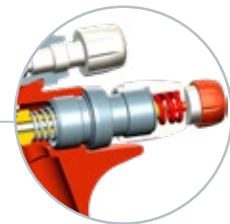

Fan regulator
 High precision

Security system
 Trigger block

TECHNICAL DETAILS

- > Max. working pressure: 200 bar
 - with yellow spring: 150 bar
 - with red spring: 200 bar
- > Air inlet: M16
- > Product inlet: 1/4"
- > Product filter: 100 mallas
- > Air consumption: 150 L/min



Code	Aircap	Air inlet	Product inlet
35130201	11/40	Quick connector 8 mm.	1/4"
35130202			Swivel coupling 1/4"
35130203		Coupling M16	1/4"
35130204			Swivel coupling 1/4"
35130205	13/40	Quick connector 8 mm.	1/4"
35130206			Swivel coupling 1/4"
35130207		Coupling M16	1/4"
35130208			Swivel coupling 1/4"

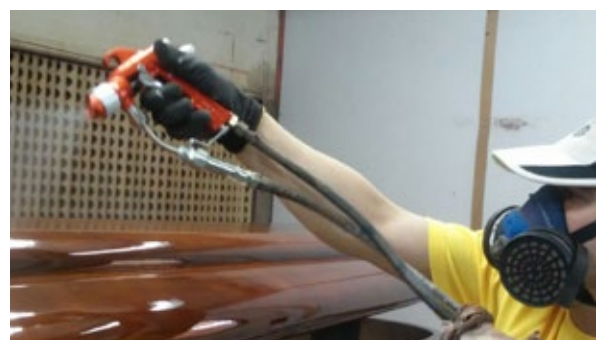



Mix aircaps (TIPS)

Application	Description	Nozzle (inch/mm)	Spray angle	Spray width (mm.) at 30 cm.	Air flow at 100 bar (L/min)	Code
Finishes	09/25 Standard - Extra Finish	0.009"/0.23	25°	140	0.25	81460518
	09/40 Standard - Extra Finish	0.009"/0.23	40°	178	0.25	81460519
	11/40 Standard - Extra Finish	0.011"/0.28	40°	190	0.37	81460529
	11/65 Standard - Extra Finish	0.011"/0.28	65°	254	0.37	81460531
Basecoats and Primers	13/40 Standard - Extra Finish	0.013"/0.33	40°	-	0.57	81460540
	13/65 Standard - Extra Finish	0.013"/0.33	65°	-	0.57	81460542
	13/80 Standard - Extra Finish	0.013"/0.33	80°	-	0.57	81460543
	15/25 Standard - Extra Finish	0.015"/0.38	25°	178	0.72	81460549
	15/40 Standard - Extra Finish	0.015"/0.38	40°	216	0.72	81460550
	15/50 Standard - Extra Finish	0.015"/0.38	50°	254	0.72	81460551
	15/65 Standard - Extra Finish	0.015"/0.38	65°	279	0.72	81460552
	15/80 Standard - Extra Finish	0.015"/0.38	80°	330	0.72	81460553
Thick layers	18/40 Standard - Extra Finish	0.018"/0.46	40°	254	-	81460575
	18/65 Standard - Extra Finish	0.018"/0.46	65°	330	-	81460577
	21/40 Standard - Extra Finish	0.021"/0.53	40°	279	1.52	81460590
	21/80 Standard - Extra Finish	0.021"/0.53	80°	-	1.52	81460593

- The fan size is indicative and it will vary depending on the viscosity and the pressure at which sprayed.
- Others available nozzle and angles. Consult.

Spray gun filter



Code	Description
56418057	Filter holder Kit (1/4 - 3/8) + Mesh filter (100+60)
56418053	Kit of 10 100-mesh spray gun filters
56418054	Kit of 10 60-mesh spray gun filters
83660037	Mix filter 100 layers
30010015	Kit of 10 microfilters mix filters

High pressure. Hose set + cover



Code	Description
86463804	5 m. (1/4" Product hose + M16 air hose) set + cover
86463869	7 m. (1/4" Product hose + M16 air hose) set + cover
86463805	10 m. (1/4" Product hose + M16 air hose) set + cover
86463806	15 m. (1/4" Product hose + M16 air hose) set + cover
56414036	7 m. (1/4" Product hose + 8 mm. air hose) set + cover *
56414037	11 m. (1/4" Product hose + 8 mm. air hose) set + cover *

*Quick coupling version

Anti-recoil filters



Code	Description
83660009	100-mesh filter
83660010	60-mesh filter

Accessories

Code	Description
OIL	
30090099	Hydraulic Oil RENOLIN MR10 (Electric Airless)
30090098	Packing oil OILPACK (Pneumatic airless/mix)
PISTON PNEUMATICS (RAIDER/MACK)	
84260099	Complete drain set
86465206	Complete absorption set
30090091	Complete deposit set
56418543	Raider 300 absorption valve set
56418542	Mack 150/320 absorption valve set
56418485	Raider 300 Lower packing set
56418498	Raider 300 Upper packing set
56418545	Mack 150/320 Lower packing set
56418546	Mack 150/320 Upper packing set
56418650	Complete hydraulic axis kit + Raider 300 packing kit
56418544	Mack 150/320 Complete hydraulic axis kit
56418652	Raider 300 Pneumatic axis kit
56418539	Mack 320 Pneumatic axis kit



Filtros Absorción

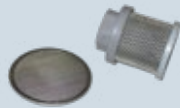

Code	Description
56418055	40 microns circular filter + spring
83660047	Special absorption filter for narrow pass

Filters and Sundry Accessories



Code	Description
83660055	High capacity filter set (1L.)
83660058	200-mesh filter
83660056	300-mesh filter
83660057	In line filter with swivel coupling, 100 mesh
30010015	Kit of 10 100-mesh micro-filters (mix aircaps)
85760301	Airless hose couplings 1/4" - 1/4"

Raider 300 and Mack 320

RAIDER 300

High Production

Easy to use

Very low air consumption

Minimum maintenance

ATEX  II 2G x

Code	Version
30951602	Trolley and absorption
30951603	Trolley and deposit
30951604	Wall and deposit
30951605	Wall and absorption
30951699	*Full equipment

Applications

Ideal for clearcoats, waterborne products, lacques, fonds, enamels and light primers.

SAGOLA introduces its new range of professional line RAIDER 300 AIRLESS version.

This line, exclusively designed and manufactured for professional use, gathers high standards both in term of performance and image.

Within the quality standards we focus on simplicity and durability.

Thus, we have redesigned completely the hydraulics. Now it contributes to a long-lasting life even in the worst working conditions and without waiving on its performance.

TECHNICAL DETAILS

- > Pressure ratio 30:1
- > Free flow (60 cycles): 1.8 L/min
- > Product output pressure: max.: 200 bar
- > Air inlet pressure max.: 7 bar
- > Air consumption: 370 L/min
- > Tip max: 0.013"
- > Weight: 15.5 kg



***Full equipment (standard),** includes Raider 300 (Trolley and absorption), PSAM 104, rotating tip, rotating head and 10 m. product hoses.

MACK 320

High production

ATEX  II 2G x

Code	Version
30932001	Trolley and absorption
30932002	Trolley and deposit
30932005	Wall and absorption
30932007	Wall and deposit
30932298	*Full equipment

Pneumatic airless pump for high performance.

Ideal for finishes in high production and waterborne products.

Reduced maintenance and self-adjusting packing system.

Clearcoats and waterborne paints, lacquers, basecoats and primers, enamels and antioxidants.

TECHNICAL DETAILS

- > Pressure ratio 32:1
- > Free flow (60 cycles): 2.7 L/min
- > Product output pressure: max.: 226 bar
- > Air inlet pressure max.: 7 bar
- > Air consumption: 610 L/min
- > Tip max: 0.018"
- > Weight: 20 kg



***Full equipment (standard),** includes Mack 320 (Trolley and absorption), PSAM 104, rotating tip, rotating head and 10 m. product hoses.



More information and application guides on page 82-83

INDUSTRIAL PAINTING
Industrial pumps
Pneumatic
Airless pump

MACK
400
MACK
600

Prepared for the application of paints with medium - high viscosities

Robust and fast with minimum maintenance

Code	MACK 400
30932201	Trolley and absorption
30932299	*Full equipment

Code	MACK 600
30932101	Trolley and absorption
30932199	*Full equipment

Mack 400 and Mack 600

High production Airless pump.

Tungsten Carbide valves.
 Enamels (polyurethanes, epoxys), anti-corrosive primers, intermediate layers and thick, chlorinated rubber, bituminous, mold release,...
 Valid for water-based product applications.

ATEX  II 2G x

***Full equipment (standard),** includes Mack 400/600 (Trolley and absorption), PSAM 107, rotating tip, rotating head and 10 m. product hoses.



TECHNICAL DETAILS

	Mack 400	Mack 600
> Pressure ratio:	40:1	60:1
> Free flow:	7.2 L/min	5.2 L/min
> Max. air consumption:	1,500 L/min	1,500 L/min
> Product output pressure max.:	240 bar	360 bar
> Pressure air inlet máx.:	6 bar	6 bar
> Weight:	62 kg	63 kg
> Supply hose minimum ø:	12.7 mm	12.7 mm
> Recommended maximum nozzle:	0.032"	0.032"
> Maximum nozzle 2 guns:	0.018"	0.018"



TECHNICAL ADVANTAGES / Airless and Mix Equipments

- 1 PNEUMATIC BODY ANODIZED FORGED ALUMINIUM.** High resistant to corrosion.
- 2 OVERSIZED PNEUMATIC CONTROL AREA.** To avoid freezing problems and maintain a smooth operation without any loss of performance.
- 3 PNEUMATIC AREA SHAFT GROUND AND CHROMIUM-PLATED.**
- 4 PRODUCT AREA SHAFTS TEMPERED AND CHROMIUM-PLATED.** Great durability and wearing resistance.
- 5 ALL PACKINGS HAVE BEEN REDESIGNED.** They offer great durability and smooth-functioning, even working at low pressure.
- 6 NEW OVERSIZED VALVES.** They provide a better product flow, a lower product flow-speed and therefore, a lower wear.
- 7 COMPACT DESIGN, STURDY and HIGH QUALITY.**
- 8 SIMPLIFIED DESIGN.** Now there are less parts, so it is easier to maintain and repair.
- 9 ANTI-PULSATION SYSTEM standard for all models.**
- REGULATORS:** AIRLESS Equipment, Pump pressure regulation system, MIX Equipment, pump and atomization regulation system.

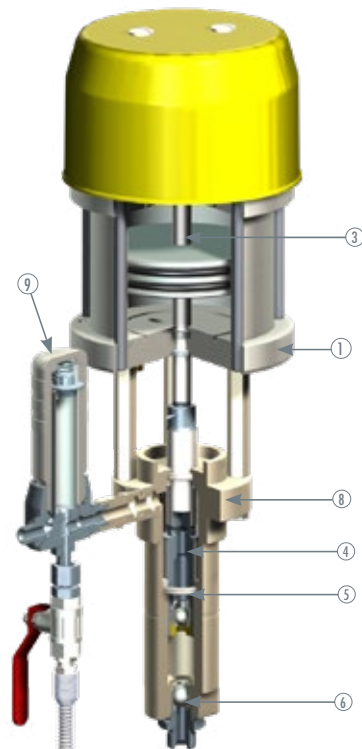

Atlanta 200 Plus and Atlanta 500

ATLANTA
200 PLUS

High-quality paints
 Medium production



Electric membrane pump. Application of clearcoats, undercoats, primers, enamels and varnishes. In general, medium viscosity products.

Code	Version
30941201	Trolley and gravity deposit
30941299	*Full equipment

TECHNICAL DETAILS

- > Single phase motor: 220V - 50 Hz.
- > Power: 1 HP
- > Free flow: 2 L/min.
- > Maximum pressure: 180 bar.
- > Maximum nozzle: 0.018"
- > Weight: 27 kg.



***Full equipment (standard),**
 includes Atlanta 200 Plus, PSAM 104,
 rotating tip, rotating head and 10 m.
 dispersions hoses of product.

ATLANTA
500

High production

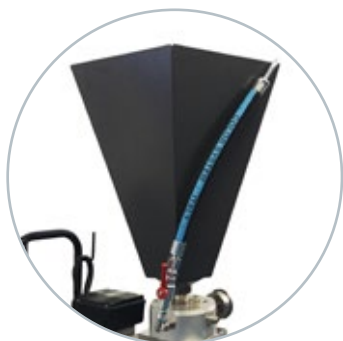

25 L Black deposit Kit

Code

30090075

Airless electric membrane pump for the application of plastic paints, primers, varnishes, chlorinated rubber, waterproof.

Code	Version
30940801	Trolley and absorption
30940899	*Full equipment

TECHNICAL DETAILS

- > Single phase motor: 220 V - 50 Hz
- > Power: 2 HP
- > Free flow: 5 L/min
- > Maximum pressure: 220 bar
- > Maximum nozzle: 0.026"
- > Weight: 53 kg



***Full equipment (standard),**
 includes Atlanta 500, PSAM 104,
 rotating tip, rotating head and 10 m.
 dispersions hoses of product.

INDUSTRIAL PAINTING
Industrial pumps
 Electric
 airless pump

Atlanta 800

ATLANTA
800

Powerful and robust for continuous tasks with 1 or 2 spray guns

Toolbox

Large size rear wheels and front steering for on-site transport

ATLANTA
800G

Petrol

100% Autonomous

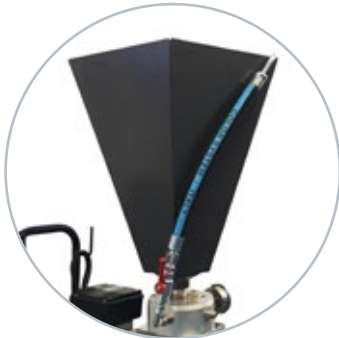

25 L Black deposit Kit

Code

30090075

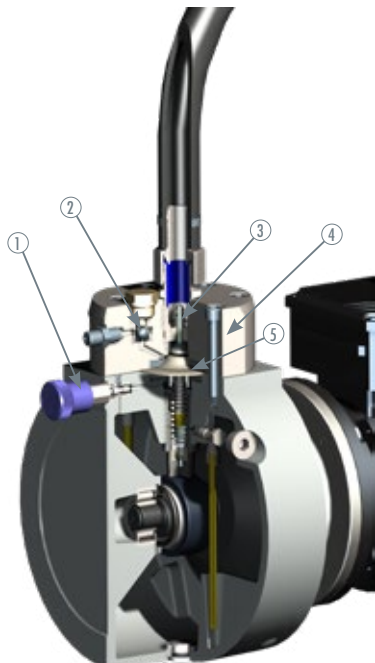

Airless electric diaphragm pump for the application of plastic paints, primers, varnishes, waterproof, fireproof, bituminous, epoxies, chlorinated rubber,....

Includes special anti-vibration system.

Code	Version
30940901	Trolley and absorption
30940999	*Full equipment

Código	Versión
30941001	Trolley and absorption



***Equipo completo (estándar),**
 incluye Atlanta 800, PSAM 107, boquilla de giro, cabezal de giro y 10 m. mangueras de dispersiones de producto.

TECHNICAL DETAILS

	Atlanta 800	Atlanta 800 G
> Maximum pressure:	220 bar	220 bar
> Free flow:	9 L/min	8.5 L/min
> Maximum recommended nozzle:	0.043"	0.036"
With 2 guns aircaps	0.023"	0.023"
> Engine Type:	Single-phase	4 stroke Honda
> Voltage:	230 V / 50 Hz	-
> Power:	2.9 H.P.	5.5 H.P.
> Sound level:	as per CE regulation: 75 DB	-



TECHNICAL ADVANTAGES / Electric Airless Pumps

- ① **PRESSURE REGULATOR**
HIGH PRECISION AND SENSITIVITY.
- ② **COMPLETE ANTI-RETURN VALVE.**
In hard metal.
- ③ **VALVE.**
In hard metal.
- ④ **PLUGS MADE OF DURALUMINIUM.**
- ⑤ **POLYAMIDE MEMBRANE**
Resistant to wear and solvent.



PSAM 107, PSAM 104 and Pole

**PSAM
107**

For professional use

Extremely robust and durable

Pressure: up to 450 bar

All the advantages of the airless system: speed, high thickness, minimum overspray

Code	Application
30170101	To use with all types of low, medium and high viscosity products.

Does not include swivel head and nozzle

* Recommended airless swivelling HEAD and AIRCAPS (see page 28)

The PSAM 107 is a high pressure airless spray gun. It is a gun for professional use with an anodised aluminium body and comfortable action due to its four-finger trigger.

It is recommended for using with all types of low, medium and high viscosity products.

Both seats and closures are manufactured in tungsten carbide. It incorporates a 1/4-inch revolving coupling and filter holder.

TECHNICAL DETAILS

- > Working pressure: 450 bar
- > Weight: 575 g
- > Screw nozzle: 11/16"



**PSAM
104**

For professional use

Code	Application
30170103	To use with all types of low and medium viscosity products.

Does not include swivel head and nozzle

* Recommended airless swivelling HEAD and AIRCAPS (see page 28)

High pressure spray gun recommended for pneumatic and electric airless systems not exceeding a working pressure of 250 bar. It is recommended for all types of medium viscosity products. Both seats and closures are manufactured in tungsten carbide. It incorporates a 1/4-inch revolving "M" coupling and filter holder.

TECHNICAL DETAILS

- > Max. Working pressure: 260 bar
- > Maximum working temperature: 80°C
- > Screw nozzle: 11/16"



Pole spray gun

For professional use

Code	Version
30170105	Pole spray gun
30990381	Pole + roller extension set

Length with roller: 915 mm.



Code
30990368

Airless gun available with die-pressed anodised body. Treated-steel trigger for operation with four fingers and with safety locking system. Both seats and closures are manufactured in tungsten carbide. It incorporates a 1/4-inch revolving "M" coupling. Application of plastic paints with a roller extension.

TECHNICAL DETAILS

- > Max. Working pressure: 220 bar
- > Swivel coupling: 1/4"
- > Weight: 470 g.



INDUSTRIAL PAINTING

Industrial pumps

Pumps and Airless spray guns accessories

Airless spray guns accessories

Airless Swivel Caps



Application	Description	Nozzle (inch/mm.)	Spray angle	Spray width (mm.) at 30 cm.	Air flow at 100 bar (L/min.)	Code	Spray gun filter
Finishes	09/20 Swivel Sd V	0.009"/0.23	20°	140	0.25	81461105	Red
	09/40 Swivel Sd V	0.009"/0.23	40°	178	0.25	81461106	
	11/20 Swivel Sd V	0.011"/0.28	20°	153	0.37	81461108	
	11/40 Swivel Sd V	0.011"/0.28	40°	190	0.37	81461109	
Basecoats and Primers	13/20 Swivel Sd V	0.013"/0.33	20°	140	0.57	81461111	Yellow
	13/40 Swivel Sd V	0.013"/0.33	40°	178	0.57	81461112	
	15/20 Swivel Sd V	0.015"/0.38	20°	148	0.72	81461115	
	15/40 Swivel Sd V	0.015"/0.38	40°	178	0.72	81461116	
	16/40 Swivel Sd V	0.015"/0.38	40°	178	0.80	81461120	
High viscosity products	17/40 Swivel Sd V	0.017"/0.43	40°	254	0.98	81461124	White
	17/60 Swivel Sd V	0.017"/0.43	60°	320	0.98	81461125	
	18/40 Swivel Sd V	0.018"/0.46	40°	254	1.10	81461128	
	18/60 Swivel Sd V	0.018"/0.46	60°	330	1.10	81461129	
	19/40 Swivel Sd V	0.019"/0.48	40°	254	1.30	81461133	
Thick Coats	21/40 Swivel Sd V	0.021"/0.53	40°	279	1.52	81461138	White
	23/40 Swivel Sd V	0.023"/0.58	40°	280	1.83	81461143	
	25/40 Swivel Sd V	0.025"/0.63	40°	305	2.13	81461148	
	25/60 Swivel Sd V	0.025"/0.63	60°	406	2.13	81461149	
	31/60 Swivel Sd V	0.031"/0.78	60°	400	2.42	81461164	

- The fan size is indicative and it will vary depending on the viscosity and the pressure at which sprayed.
 - Others available nozzle and angles. Consult.

Fixed airless tips



Application	Description	Nozzle (inch/mm.)	Spray angle	Spray width (mm.) at 30 cm.	Air flow at 100 bar (L/min.)	Code	Spray gun filter
Finishes	09/25 Fixed	0.009"/0.23	25°	140	0.25	81460641	Red
	09/40 Fixed	0.009"/0.23	40°	178	0.25	81460642	
	09/65 Fixed	0.009"/0.23	65°	235	0.25	81460644	
	11/40 Fixed	0.011"/0.28	40°	190	0.37	81460650	
	11/65 Fixed	0.011"/0.28	65°	254	0.37	81460653	
Basecoats and Primers	13/25 Fixed	0.013"/0.33	25°	140	0.57	81460661	Yellow
	13/40 Fixed	0.013"/0.33	40°	178	0.57	81460662	
	13/65 Fixed	0.013"/0.33	65°	254	0.57	81460665	
	13/80 Fixed	0.013"/0.33	80°	292	0.57	81460666	
	15/25 Fixed	0.015"/0.38	25°	178	0.98	81460672	
	15/40 Fixed	0.015"/0.38	40°	216	0.98	81460673	
	15/50 Fixed	0.015"/0.38	50°	254	0.98	81460674	
	15/65 Fixed	0.015"/0.38	65°	279	0.98	81460675	
	15/80 Fixed	0.015"/0.38	80°	330	0.98	81460676	
	17/100 Fixed	0.017"/0.43	100°	380	1.30	81460641	
Thick Coats	18/40 Fixed	0.018"/0.46	40°	254	1.12	81460627	White
	18/65 Fixed	0.018"/0.46	65°	330	1.12	81460701	
	21/40 Fixed	0.021"/0.53	40°	279	1.52	81460714	

- The fan size is indicative and it will vary depending on the viscosity and the pressure at which sprayed.
 - Others available nozzle and angles. Consult.

Airless tips adjustable fan pattern



Swivel head



Code	Description
81460977	15 reg. spray pattern airless tips
81460978	20 reg. spray pattern airless tips

Code	Spray gun
81461101	PSAM 107/104

Airless pumps accessories

Angular head

Code	Spray gun
30990371	PSAM 107/104



Extensions

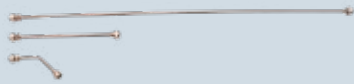

Code	Description
30010302	300 mm. airless extension
30010303	500 mm. airless extension
30010304	1,000 mm. airless extension
30010301	150 mm. 45° airless extension

Accesorios para Pole

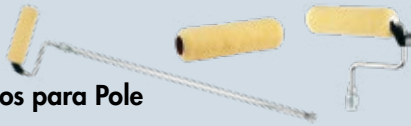

Code	Description
30990370	Spare parts for roller
30990369	Roller for extension
30990368	915 mm. extension kit with roller

Cleaning

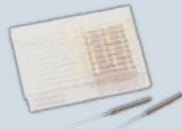

Code	Description
30010207	Cleanliness needles (12 pcs.)

Spray gun filters



Code	Description
30010008	1 - White airless 10 filters Kit
30010009	2 - Yellow airless 10 filters Kit
30010010	3 - Red airless 10 filters Kit
86463004	4 - Filter kit 100 sheets

Filter Accessories Pump Anti-recoil



Code	Description
83660009	100-mesh mix/airless filter
83660010	60-mesh mix/airless filter

Absorption Filters

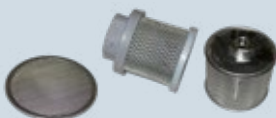

Code	Description
56418055	40 microns circular filter + spring
83660047	Special absorption filter for narrow pass
30090034	Absorption head for electric airless
53610510	Black deposit filter kit for electric airless

Code	Description
OIL	
30090099	Hydraulic Oil RENOLIN MR10 (Electric Airless)
30090098	Packing oil OILPACK (Pneumatic airless/mix)
ELECTRIC MEMBRANE UNITS (ATLANTA)	
30090021	Antireturn valve - 200 Plus/500/800
87560001	Absorption valve - 200 Plus
87560003	Absorption valve - 200 Plus/500/800
56418599	Membrane kit (includes seat and oil) - 200 Plus
30090022	Membrane kit (includes seat and oil) - 500/800
86464701	Pressure regulator - 200 Plus
86464703	Pressure regulator - 500/800
30090087	Drain set - 500
86465204	Full absorption sensor - 500/800
PISTON PNEUMATICS (RAIDER/MACK)	
84260099	Complete drain set
86465206	Complete absorption set
30090091	Complete deposit set
56418543	Raider 300 absorption valve set
56418542	Mack 150/320 absorption valve set
56418485	Raider 300 Lower packing set
56418498	Raider 300 Upper packing set
56418545	Mack 150/320 Lower packing set
56418546	Mack 150/320 Upper packing set
56418650	Complete hydraulic axis kit + Raider 300 packing kit
56418544	Mack 150/320 Complete hydraulic axis kit
56418652	Raider 300 Pneumatic axis kit
56418539	Mack 320 Pneumatic axis kit



Airless product hose



Code	Description
86463802	10 m. W/Th Dispersal hose, electric machines
86463803	20 m. W/Th Dispersal hose 1/4", electric machines
86463821	5 m. with Therminals 3/16" hose
86463826	5 m. product hose 1/4" - with Therminals
86463827	10 m. product hose 1/4" - with Therminals
86463828	15 m. product hose 1/4" - with Therminals
86463834	10 m. product hose 1/4" - with Safety Therminals

Filters and Sundry Accessories



Code	Description
83660055	High capacity filter set (1L.)
83660058	200-mesh filter
83660056	300-mesh filter
83660057	In line filter with swivel coupling, 100 mesh
85760301	Airless hose couplings 1/4" - 1/4"

INDUSTRIAL PAINTING
Industrial pumps
Industrial turbines

TURBO3000
PRO

High performance

Maximum quality

Very wide fan patterns

Nozzle and needle in stainless steel

3-stage turbine



Code	Version
30640201	Complet equipment 220 V / 50 Hz

Turbo 3000 Pro and Turbo 2200 Pro



Professional HVLP autonomous tool. High performance.

Minimum mist.

Autonomous Turbine Equipment for the application of dyes, lacquers, enamels, clearcoats, primers, textured products and cast iron effect.

Ideal for painting and assemblies works.

Metallic spray gun with fan and product regulators. Deposit with anti-return valve, flange closure and anti-drip lid.

Includes double removable air filter.

Code	Description
56418597	Turbo 3300 PRO Turbine air filters kit (6 units)

TECHNICAL DETAILS

- > Electric motor: Direct Current
- > Power: 1,400 w
- > Motor consumption: 6.1 Amp.
- > Free flow: 2,500 L/min
- > Maximum working pressure: 0.3 bar
- > Hose length: 8 m.
- > Weight: 12 kg
- > Transfer: 75%



Combinations SAGOLA 455 Spray Gun



Code	Version	Application
10110501	1.40 [80]	Finishes, basecoats and primers
10110502	1.00 [80]	High gloss finishes and dyes
10110503	1.20 [80]	General finishes
10110505	1.80 [80]	Viscous products, primers, acrylics
10110506	2.00 [80]	Textured products, cast iron effect

Air regulator in turbine hose



TURBO
2200PRO

Very wide fan patterns

Stainless steel nozzle and needle

3-stage turbine

TECHNICAL DETAILS

- > Electric motor: 220 V - 50 Hz
- > Power: 1,300 w
- > Free flow: 2,000 L/min.
- > Maximum working pressure: 0.3 bar
- > Weight: 10 kg
- > Transfer: 75%



Autonomous Turbine Equipment for all type of industry, with a power of 1,300 w.

Excellent atomization. Ideal for painting and assemblies works.

Metallic spray gun with fan and product regulator. Deposit with anti-return valve, flange closure and anti-drip lid.

Hose length 6 meter
Removable double air filter.

Code	Version
30640401	Complet equipment 220 V / 50 Hz



Code	Version
56418663	Turbo 2200 PRO Turbine air filters kit (6 units)



Industrial pressure pots

SAGOLA pressure pots come into their own when pumping equipment demands the maximum durability and minimum maintenance, even with the most abrasive paints (ceramic and vitro-ceramic clears, cast iron effect, pastes...) or corrosive products (dyes, waterborne paints, waterborne adhesives...).

- > Manufactured in stainless steel.
- > Produced according to the most demanding international standards.
- > Extreme manufacturing quality and precision.
 - > Maximum safety.



INDUSTRIAL PAINTING

Industrial pressure pots
Upper outlet pots

6110 INOX

Made of stainless steel
10 L. capacity

Double, high precision, robust regulator with anti-return valve

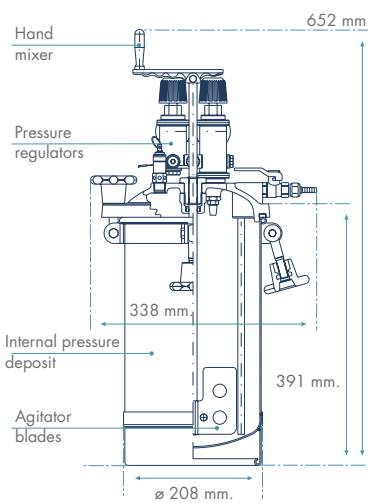

Code	Version
52411607	10 L. stainless steel interchangeable tank

6110 INOX Co

Special for adhesives

Recommended for SAGOLA adhesive guns

10 L capacity

Code

10550202

6110 Inox and 6110 Inox Co pressure pots

Offers the maximum durability due to the stainless steel body and lid.

Double, high precision, robust regulators with anti-return valve.

Valid for waterborne and solvent-based paints.

6110 homologation:

- > SPAIN: AP 1070 FBZ 2330
- > FRANCE: CODAP
- > GREAT BRITAIN: British Standard 1101-1977
- > GERMANY: A.D. Merkblätter
- > ATEX II 2G x

TECHNICAL DETAILS

- > Hand mixer
- > Optional interchangeable stainless steel deposit
- > Maximum inlet pressure: 4 bar
- > Air inlet: 1/4" BSP
- > Product outlet: 3/8" BSP
- > Product pressure gauge: 0 - 4 bar
- > Air pressure gauge: 0 - 8 bar



Code	Version
10540702	6110 Inox pressure pot
10540799	*Full equipment

The 6110 has a special version for bead application of adhesives which differs from its predecessor in the greater pressure it can handle (up to 7 bar), in addition to the absence of the agitator and the single regulator.

6110 homologation:

- > SPAIN: AP 1070 FBZ 2330
- > FRANCE: CODAP
- > GREAT BRITAIN: British Standard 1101-1977
- > GERMANY: A.D. Merkblätter
- > ATEX II 2G x

Certificate No.: FBC - 9168

TECHNICAL DETAILS

- > Maximum working pressure: 7 bar
- > Air inlet: 1/4" BSP
- > Product outlet: 3/8" BSP
- > Product pressure gauge: 0 - 8 bar



The full equipment includes: 6110 INOX pressure pot, air + product hose (5 m.) and X 4100 series pressure spray gun.



610, 612 pressure pots and hoses

610
 Pressure pot

Code	Version
40000273	610 pressure pot
10540798	*Full equipment

***Full equipment:** includes 610 pressure pot, air and product hoses (5 m.) and 3300 GTO pressure 1.40 [EPA].

Steel body and aluminium lid.
 Top outlet. Valid for solvent-based paints.
 Low and medium viscosity paints.
 > ATEX  II 2G x

TECHNICAL DETAILS

- > 10 liters capacity
- > Without product agitator
- > Double regulation
- > Valid for solvent-based paints
- > Working pressure: max. 4 bar
- > Product outlet: 3/8"
- > Air inlet: 1/4"



612

Easy to use
 Robust

Minimum maintenance

Ideal for Industrial bodyshop

Code	Version
10540801	612 pressure pot
10540899	*Full equipment

Air + product hose Kit. 1.8 m.

Code
56414128

Pressure pot. Aluminum body and lid.
 2.5 litres deposit capacity.
 Top outlet and pressure regulator.
 Valid for waterborne and solvent-based paints.
 > ATEX  II 2G x

TECHNICAL DETAILS

- > Pressure ratio 1 : 1
- > Deposit capacity: 2.5 L
- > Working pressure: max.: 3.3 bar
- > Air inlet: 1/4"
- > Product outlet: 3/8"



***The full equipment** includes: 612 pressure pot, X 4100 series Pressure 1.20 [XT01 B] and 1.8 m. air and product hoses.

Air hoses for PRESSURE POTS



Air hoses. Anti-static

Code	Description
56414014	2.5 m. 6x12 mm. F/F 1/4"
56414024	6 m. 8x15 mm. F/F 1/4"
56414025	11 m. 8x15 mm. F/F 1/4"
56414027	16 m. 8x15 mm. F/F 1/4"
56414026	26 m. 8x15 mm. F/F 1/4"

Product hose

Aerographic hose for Waterborne/Solvent.
 8x16 mm. F/F 3/8"

Code	Description
56414116	6 m. 8x16 mm. F/F 3/8"
56414117	11 m. 8x16 mm. F/F 3/8"
56414115	16 m. 8x16 mm. F/F 3/8"

Air + Product hose. Aerographics

Code	Description
86463818	5 m. spray gun hose set. (6 mm. + 8 mm.) HVLP
86463819	10 m. spray gun hose set. (6 mm. + 8 mm.)
86463891	Adhesives 10 m. air hose 8 mm. + 10 mm. Product hose
86463894	Dyes 5 m. air hose 8 mm. + 3 mm. Product hose

Air + Product hose + cover. Aerographics. Lights

Code	Description
56414039	5 m. Air hose 8x15 mm. + product hose 6x8 mm. set + cover
56414040	10 m. Air hose 8x15 mm. + product hose 6x8 mm. + cover
56414041	15 m. Air hose 8x15 mm. + product hose 6x8 mm. + cover
56414042	20 m. Air hose 8x15 mm. + product hose 6x8 mm. + cover

High Viscosity product hose. Aerographics

Code	Description
56414111	Product Hose 5 m. 19 x 26 mm. F/F 3/4". Waterborne
56414112	Product Hose 10 m. 19 x 26 mm. F/F 3/4". Waterborne
56414113	Product Hose 15 m. 19 x 26 mm. F/F 3/4". Waterborne
56414101	Product Hose 5 m. 25 x 33 mm. Kamlock Kit. Waterborne
56414129	Product Hose 10 m. 12 x 21 mm. F/F 3/4". Solvent

INDUSTRIAL PAINTING

Industrial pressure pots

Upper outlet pots

652 Inox and 653 Inox

652 Inox

25 L. stainless steel pot

Optional interchangeable deposit

Code	Version	
10540320	652 Inox MDS	Manual agitator, double regulation, without wheels
10540321	652 Inox RDC	Pneumatic rotary agitator, double regulation, with wheels
10540322	652 Inox ADC	Pneumatic alternative agitator, double regulation, with wheels



TECHNICAL DETAILS

- > 25 liters capacity
- > Top outlet
- > With manual agitator
- > Maximum working pressure: 4 bar.



ATEX II 2G X
Certificate No.: AP - 1035

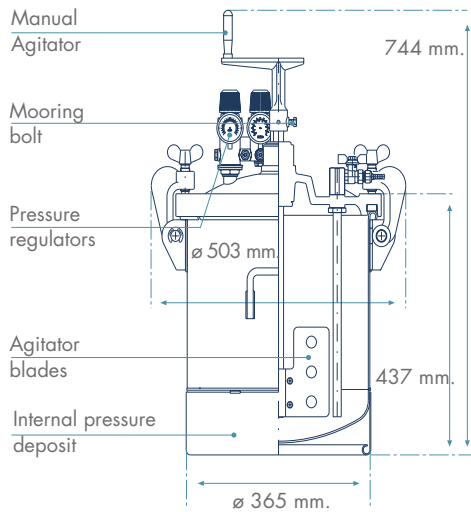

Code	Version
52411608	25 L. stainless steel interchangeable tank

653 Inox

50 L. stainless steel pot

Optional interchangeable deposit

Code	Version	
10540420	653 Inox MDS	Manual agitator, double regulation, without wheels
10540421	653 Inox RDC	Pneumatic rotary agitator, double regulation, with wheels
10540422	653 Inox ADC	Pneumatic alternative agitator, double regulation, with wheels



TECHNICAL DETAILS

- > 50 liters capacity
- > Top outlet
- > With manual agitator
- > Maximum working pressure: 4 bar



ATEX II 2G X
Certificate No.: AP - 1035

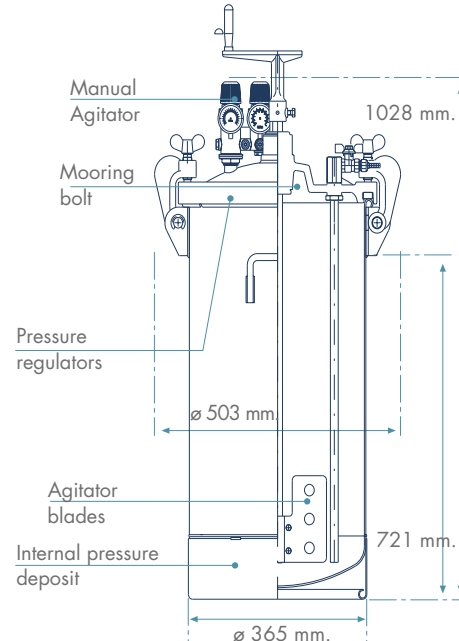

Code	Version
52411609	50 L. stainless steel interchangeable tank

Premium 30, Premium 60 and Classic 30 Inox



*Pinturas Lisas, Colas
Alta viscosidad*



*Pastas pétreas, Rugosos
y Slurry*

Premium 30

With double handlebar,
foldable for transport

Two handles for holding

Code

20530520

30 L. pressure pot (two 25 Kg. bags of paste). Two lower product outlets:

a) for dense products (20 mm interior Ø. hose and 3/4" thread).

b) for regular products (8 mm interior Ø. hose and 3/8" thread).

Application of gotelé, plastic paints, thick products and paints in general of medium and low viscosity.



TECHNICAL DETAILS

- > Maximum working pressure: 7 bar
- > Homologation No. FBZ-2330
- > ATEX 2 II GX



Premium 60

With double handlebar,
foldable for transport

Two handles for holding

Code

20530620

60 L. pressure pot (two 25 Kg. bags of paste). Two lower product outlets:

a) for dense products (20 mm interior Ø. hose and 3/4" thread).

b) for regular products (8 mm interior Ø. hose and 3/8" thread).



TECHNICAL DETAILS

- > Maximum working pressure: 7 bar
- > Homologation No. FBZ-2330
- > ATEX 2 II GX



Classic 30 Inox

With handlebar,
foldable for transport

Code

20530702

30 L. pressure pressure pot. (two bags of 25 kg. of paste).

TECHNICAL DETAILS

- > Maximum working pressure: 7 bar
- > Bottom-mounted product outlet 3/4"
- > Empty weight: 31 kg.
- > ATEX 2 II GX



INDUSTRIAL PAINTING
Industrial pressure pots
Pneumatic
Mixers

463/ 471 & 446/ 464



463



471

463/ 471

Pneumatic motor and alternative agitator.

Code	Version
10510201	Pneumatic motor 463
10520201	Alternative agitator 471

TECHNICAL DETAILS

- > Fits pots 652 and 653
- > Air consumption: 28 L/min (1 CFM)
- > Speed regulator: 10 - 20 oscillations/min
- > Working pressure: 1 to 6 bar (14.5 to 87 psi)
- > Makes alternative oscillating movements through 180°
- > Air inlet: BSP 1/4"
- > ATEX  II 2G x



446



464

446/ 464

Pneumatic motor and rotary agitator.

Code	Version
10510101	Pneumatic motor 446
10520101	Rotary agitator 464

TECHNICAL DETAILS

- > Fits pots 652 and 653
- > Air consumption: 392 L/min (14 cfm)
- > Speed regulator up to 300 r.p.m.
- > Power: 0.5 HP
- > Working pressure: 1 to 6 bar (14.5 to 87 psi)
- > Air inlet: BSP 1/4"
- > ATEX  II 2G x



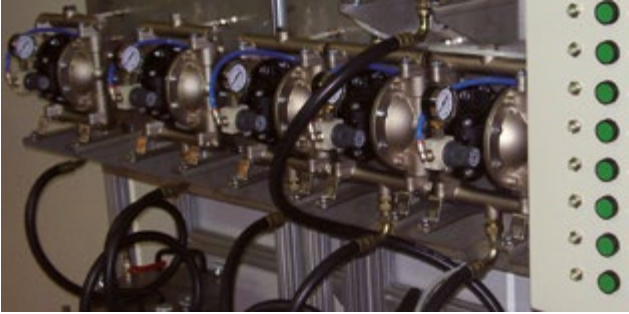

DM400, DM300 & TB270 Inox

DM 400

Double membrane fluid supply pump. Clearcoats, paints solvents, dyes, lubricants, glues and adhesives, oils and dirty oils. In general, low and medium viscosity products.

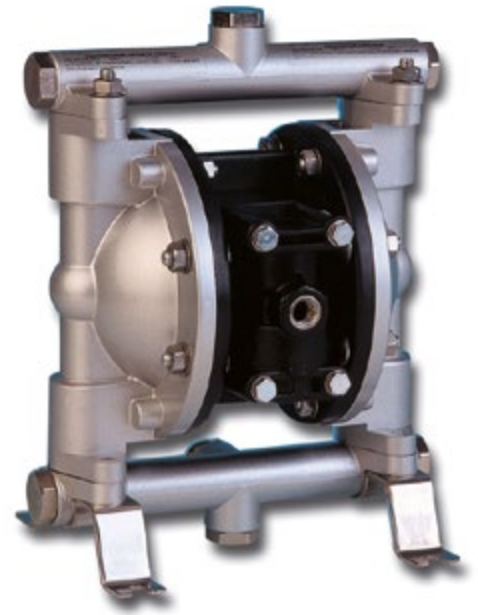

Code	Version
30910101	Basic. Standard products
30910102	Basic. Abrasive products

TECHNICAL DETAILS

- > Pressure ratio 1:1
- > Maximum flow 40 L/min
- > Maximum pressure: 7 bar
- > Air consumption: 580 L/min
- > Weight: 4.7 kg
- > Air inlet: BSP 1/4"
- > Product Inlet and outlet: 1/2"
- > ATEX II 2G x



DM 300

Double membrane fluid supply pump.

Clearcoats, glues and adhesives, laquers, paints solvents, dyes, oils and dirty oils. Generally, low and medium viscosity products.

Code	Version
30910105	Basic. Standard products

TECHNICAL DETAILS

- > Pressure ratio 1:1
- > Maximum flow 30 L/min
- > Maximum pressure: 7 bar
- > Air consumption: 380 L/min
- > Weight: 3.3 kg
- > Air inlet: BSP 1/4"
- > Product Inlet and outlet: BSP 3/8"



TB270 Inox

Fluid supply piston pumps.

Clearcoats, paints solvents, dyes, lubricants, glues and adhesives. Stainless steel versions for corrosive and waterborne products.

Special for recipients.

Code	Version
30910501	TB 270 Long/Aluminium
30910502	TB 270 Short/Aluminium
30910503	TB 270 Long/S. Steel
30910504	TB 270 Short/S. Steel

TECHNICAL DETAILS

- > Pressure ratio 1:1
- > Maximum flow 60 L/min
- > Maximum pressure: 7 bar
- > Air consumption: 230 L/min
- > Weight: 7 kg
- > Air inlet: BSP 1/4"
- > Product outlet: BSP 3/4"
- > Recipient thread: BSP 2"
- > ATEX II 2G x



INDUSTRIAL PAINTING

Industrial pressure pots

Pumps and
fluid supply syst.

Recipient Lid



ATEX  II 2G x

Recipient lid kit

Stainless steel

Code	Version
30990354	For 200 L. recipient



**Recipient lid kit
+ rotary agitator**

Code	Version
30990359	For 200 L. recipient

**Recipient lid kit
+ DM pump
+ Air inlet regulator**

Code	Version
30990358	For 200 L. recipient



**Recipient lid kit
+ DM pump + rotary agitator
+ Air inlet regulator**

Code	Version
30990356	For 200 L. recipient

**Recipient lid kit
+ TB 270 pump
+ Air inlet regulator**

Code	Version
30990357	For 200 L. recipient



**Recipient lid kit
+ TB 270 pump
+ rotary agitator
+ Air inlet regulator**

Code	Version
30990355	For 200 L. recipient

Aerographic spray guns

SAGOLA aims to provide **the best response to industrial painting needs** with this range of spray guns.

- > Maximum productivity
- > Improved productivity of the painting line
- > Time and product savings
- > Minimization of mist and solvent emissions
- > Cost reductions related to equipment maintenance
- > Achieving the maximum finishing quality standards

SAGOLA offers all its experience in finishing to supply industrial painting sectors with **highly competitive tools and equipment** for the following sectors:

- > **Wood, metal, plastic, industrial vehicle and automotive production lines, industrial machinery, maritime, ceramics, tannery finishes...**

Our daily commitment: to respond to the new challenges in paints and coatings for industrial surfaces.

- > Finishes with the maximum gloss requirements
- > High-solid paints and clearcoats and waterborne finishes
- > Dyes and metallized products
- > Paints, ceramics and abrasive and corrosive products

With the aim of meeting these objectives we offer **high transfer spray guns** which meet the most demanding solvent emission regulations and standards:

- > **HVLP** and **EPA, Mix, Airless** spray guns...



INDUSTRIAL PAINTING
Aerographic spray guns
 Suction
 spray guns

X 4100 series Suction

X4100
SERIES



Forged aluminium body
 High quality chromed finish

Nozzle and needle
 on a single stainless steel part



Aluminium high capacity deposit (1L)
 Double watertight gasket system
 Clamp gasket and anti-drip lid

Maximum use of paint level



Forged and anodized aluminum body of great robustness and high corrosion protection

Ideal for painting large areas, machinery and industrial vehicles

Extra deposit capacity and application speed

Ideal for continuous work sessions and large surfaces

More comfortable painting and less tiredness due to the low gravity center



Suction system of our 4100 allows painting at right angles with the piece when painting bonnets, roofs, vehicles' inside parts, trucks' chassis, trailers, etc.

TECHNICAL DETAILS

- > Weight with deposit: 920 g
- > Dimensions with deposit: 29.6 x 18.3 x 10.5 cm
- > Air inlet couplings BSP 1/4" male
- > Design pressure: 8 bar
- > Maximum recommended inlet pressure (working pressure): 2 - 2.5 bar
- > Recommended application distance: 18 - 22 cm
- > Max. paint flow output (nozzle 1.4 mm. 20"):
 Aircap 96: 168 g/min
 Aircap XT01: 175 g/min
- > Air consumption:
 Aircap 96: 280 L/min
 Aircap XT01: 295 L/min
- > Fan size:
 Aircap 96: 235 - 285 mm
 Aircap XT01: 255 - 295 mm
- > Materials in contact with the product:
 INOX, chromed aluminium, POM, Teflon, Nylon.
- > ATEX II 2G T60°C X

Sagola presents its new **X 4100 Series** especially for the industrial painting sector. We maintain all the quality standards of its predecessor the 4100 and incorporate new aspects. All this makes it the perfect tool for work with very high demands in terms of quality of finish, robustness and ergonomics for continuous work.

Medium pressure
 55% Transfer

96
 Max. spraying quality

EPA System
 65% Transfer

XT01 EPA
 High performance
 High quality



Code	Version	Application
10121001	1.40 [96]	General finishes
10121006	1.60S [96]	General finishes
10121003	1.80 [96]	Finishes and Primers. High speed
10121007	1.60S [XT01]	Top quality finishes
10121005	1.80 [XT01]	High speed. Large surfaces

3300 GTO

3300 GTO Suction

Lighter and robust

New body, maximum ergonomics

Time saving

Top-range and Low consumption High-end Aluminium aircaps

There are no gaskets in couplings between air and paint

Versatile

Extra deposit capacity (1L.)

REGULATIONS / PATENTS / REGISTRATIONS

SAGOLA registers the shapes of its guns and its brand/trademark worldwide, and complies with the strictest safety standards and with the strictest standards on solvent emissions:

- > CE
- > EN 1953
- > ATEX  II 2G x
- > Design in EU: D-C 924667-0004
- > Design in Asia: 200830139660.3



Application of enamels, varnishes, primers and basecoats.

Nozzles and needles in stainless steel.

HVLP and EPA aircaps that comply with regulations concerning solvent emissions.

EPA aircap: Minimum air consumption with high quality application.

With a light injected-aluminium body, it is a top level product with an excellent price/quality ratio.

High performance. High speed application. Large size fan.

TECHNICAL DETAILS

- > Weight: 925 g
- > Dimensions: 29 x 17.5 x 11 cm
- > Product inlet: 3/8" M BSP
- > Air inlet: 1/4" M BSP
- > Design pressure: 8 bar
- > Maximum recommended inlet pressure (working pressure): 2 bar
- > Maximum recommended application distance:
3300 EPA: 15 - 18 cm
- > Air consumption (2 bar inlet):
3300 EPA: 240 L/min
- > Average sound pressure level: 80 dB
- > Materials in contact with product:
chromed aluminium, anodized aluminium, POM, INOX, Teflon.

EPA System
65% Transfer
EPA
Low air consumption



Code	Version	Application
10120910	1.40 [EPA]	High quality finishes. Dyes, metallics
10120911	1.60 [EPA]	General finishes
10120912	1.80 [EPA]	Primers and finishes

INDUSTRIAL PAINTING
Aerographic spray guns
 Suction
 spray guns

Classic Pro Suction and 3300 New Press

Classic Pro Suction

Maximum ergonomics

Maximum robustness
 and reliability

Low air consumption

Smooth trigger action

High spray quality

The best price-quality ratio in conventional spray guns.

Aluminium regulators.

Single spindle design means fewer parts.
 One-piece packing nut. There are no O-rings.

Stainless steel nozzle and needle.

Code	Version	Application
10120701	1.60 [21]	General finishes
10120702	1.80 [21]	Primers and basecoats

TECHNICAL DETAILS

- > Weight with deposit: 928 g
- > Dimensions: 29 x 17.5 x 11 cm
- > Air inlet coupling thread BSP 1/4" male
- > Maximum air pressure: 8 bar
- > Maximum recommended inlet pressure (working pressure): 2.5 - 3.0
- > Maximum recommended application distance: 20 - 25 cm.
- > Air consumption: 21 Aircap : 210 L/min
- > ATEX  II 2G x



3300 New Press

Teflon-coated body
 makes cleaning easy

ATEX  II 2G x

Spray gun with pressurised deposit, ideal for the application of medium and high viscosity products.

Multiple regulators (fan pattern, flow, product).



Code	Version	Application
10151511	2.00 [27]	Multi-colour paints for the construction industry. Very low air consumption.
10151512	2.00 [64]	Textured effects for industry



X4100 SERIES

X 4100 series Gravity

Catalogue 2021

INDUSTRIAL PAINTING Aerographic spray guns Gravity spray guns



Forged anodized aluminium body

Robustness and high protection against corrosion.

More rounded, ergonomic and comfortable grip.

A perfect balance in the movements.

New modern design of regulators.

Without edges. Easy to clean.



Trigger and axle made in stainless steel. Ultra-ergonomic design.

Nozzle and Needle in INOX

All records in contact in the body made of Stainless steel



One piece product packing nut
Made in Stainless Steel.

Exclusive on the market

With no joints to manipulate when disassembling for through cleaning of the paint part



Sagola presents its new **X 4100 Series** especially for the industrial painting sector. We maintain all the quality standards of its predecessor the 4100 and incorporate new aspects. All this makes it the perfect tool for work with very high demands in terms of quality of finish, robustness and ergonomics for continuous work.

Ideal for painting large areas with extreme finishing in sectors such as automotive, industrial vehicles and all types of industrial machinery.

Nuevo body design, lightweight and ergonomic. Anodized forged aluminum body. Maximum durability and minimum maintenance.

TECHNICAL DETAILS

- > Weight without deposit: 504 g
- > Dimensions without deposit: 17.3 x 17.2 x 4.2 cm
- > Air inlet coupling thread BSP 1/4" male
- > Deposit capacity: 650 ml
- > Deposit with removable anti-drip system
- > Incorporates 100-mesh paint filter
- > Maximum air pressure: 8 bar
- > Maximum recommended inlet pressure (working pressure): 2 bar.
- > Maximum recommended application distance:
 - 64S/96+: 20 - 25 cm
 - XT01: 18 - 20 cm
 - XT03 HVLP: 12 - 15 cm
- > Air consumption:
 - 64S: 305 L/min
 - 96: 250 L/min
 - XT01: 235 L/min
 - XT03: 465 L/min
- > Materials in contact with the product:
 - INOX, anodized aluminium,
 - POM, Teflon and Nylon.
- > ATEX II 2G T60°C X

Medium Pressure System
55% Transfer
96
High quality
64 S
Max. atomization



EPA System
65% Transfer
XT01 EPA
High performance
High quality



HVLP System
72% Transfer
XT03 - HVLP
Minimum mist



Code	Version	Application
10142012	1.30 [96]	Fluid finishes, metallics, dyes
10142001	1.40 [96]	High quality finishes
10142002	1.60 [96]	General finishes
10142003	1.80 [96]	Primers and basecoats
10142011	2.20 [64S]	High viscosity products
10142004	1.30 [XT01]	Dyes
10142005	1.40 [XT01]	General finishes
10142006	1.60 [XT01]	High speed finishes
10142007	1.30 [HVLP]	Dyes
10142008	1.40 [HVLP]	General finishes
10142009	1.60 [HVLP]	Finishes. High speed
10142010	1.80 [HVLP]	Primers and basecoats

Ask for Tungsten Carbide special nozzles

INDUSTRIAL PAINTING

Aerographic spray guns

Gravity spray guns

Mini Xtreme Gravity

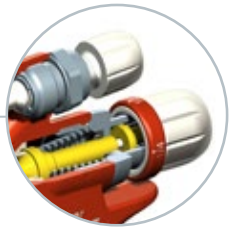

High precision aluminium **product and fan pattern regulators** designed for easy handling even when wearing gloves.

Numbered product regulator for totally accurate paint control.

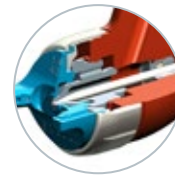

There are no gaskets in couplings between air and paint
Designed without O-rings in the air system

Couplings in stainless steel



SSAGOLA Xtreme system in compact size
Thoughtful grip design



Code

55711622

Connection coupling
M12 male - 1/4" female

Mini Xtreme

Small and light, with perfect ergonomics

Perfect for retouching in vehicle production lines

Ideal for parts coating: wood, plastic and tannery products

Highest quality finishes

Solid: manufactured in forged aluminium

Perfect for dyes and metallized products

500 c.c. deposit

"Control" is the word that best defines the new SAGOLA Mini Xtreme.

It ensures the perfect air-paint ratio for every situation. Work with the correct fan pattern sizes without running the risk of overloading and wrong paint particle sizes. It reduces mist, saves paint and perfectly defines the work zone.

Fan patterns designed to obtain the best drying times with the finest finish, always with minimum pressures.

Specific high-transfer aircaps with an exclusive air diffusion system to achieve a smooth spraying with low pressure.



TECHNICAL DETAILS

- > Weight with deposit: 505 g
- > Dimensions: 29 x 16 x 11 cm
- > Air inlet coupling thread 1/4" male
- > Deposit capacity: 500 ml
- > Deposit with removable anti-drip system
- > Incorporates 100-mesh paint filter
- > Maximum air pressure: 8 bar
- > Maximum recommended inlet pressure (working pressure): 2.0 bar
- > Maximum recommended application distance:
 - Mini EPA: 15 - 18 cm
 - Mini HVLP: 10 - 15 cm
 - Mini TECH: 15 - 18 cm
- > Maximum Air consumption:
 - Mini EPA: 200 L/min
 - Mini HVLP: 310 L/min
 - Mini TECH: 52 L/min
- > Materials in contact with the product:
 - INOX, anodised aluminium,
 - POM, Teflon, Nylon.
- > ATEX II 2G T60°C X



Code	Version	Application
10111806	0.80 [Mini EPA]	Fine feathering, basecoats
10111807	1.00 [Mini EPA]	Retouching, feathering. Waterborne and solvent-based basecoats. Clearcoats and dyes
10111808	1.00 [Mini EPA]	Clearcoats, UV paints Extremely high finish quality
10111804	1.30 [Mini HVLP]	Especially for dyes: wood, tannery products, footwear
10111805	1.40 [Mini HVLP]	Finishes, dyes
10111811	0.60 [Mini TECH]	Primers for leather with low viscosity products
10111812	1.00 [Mini TECH]	Lettering and small retouches

EPA System
65% Transfer
Mini EPA



HVLP System
75% Transfer
Mini HVLP



Round Jet System
Chorro redondo





3300 GTO Gravity

Light weight
New body,
maximum ergonomics

Time saving
Top quality
aluminium aircaps

There are no O-rings

New 3300 GTO model. SAGOLA sets the pace in the mid to high range of spray guns for finishes. Forged and anodized aluminum body. This is a top level product with a magnificent price-quality ratio.

EVO aircap: High quality finishes with high-speed industrial application.

EPA aircap: minimum air consumption with high quality application (>2HP).

HVLP aircap: maximum paint savings and minimum mist.



3300
GTO



Ergonomic trigger

Made of Stainless Steel
Reduces fatigue



New Product regulator

Air Flow, paint flow and fan control redesigned.

Improved balance

Perfect distribution of material, reinforcing critical areas.



Automatic packing gland

Perfect adjustment to the needle. Less risk of damaging the needle. Less contamination of paint.

TECHNICAL DETAILS

- > Weight with deposit: 423 g
- > Dimensions including deposit: 34.5 x 10 x 18 cm
- > 1/4" BSP air inlet coupling
- > Deposit capacity: 650 ml
- > Deposit with removable anti-drip system
- > Design pressure: 8 bar
- > Maximum recommended inlet pressure (working pressure): 2 bar
- > Recommended application distance: 18 - 20 cm
- > Fan size:
 - GTO HVLP: 245 - 295 mm
 - GTO EPA: 225 - 245 mm
 - GTO EVO: 260 - 280 mm
- > Air consumption (2 bar inlet):
 - GTO HVLP: 360 L/min
 - GTO EPA: 250 L/min
 - GTO EVO: 255 L/min
- > Average sound pressure level: 80 dB
- > Materials in contact with product: anodized aluminium, chromed aluminium, POM, INOX, Teflon.



REGULATIONS / PATENTS / REGISTRATIONS

SAGOLA registers the shapes of its guns and its brand/trademark worldwide, and complies with the strictest safety standards and with the strictest standards on solvent emissions:

- > CE
- > EN 1953
- > ATEX II 2G T60°C X
- > SQMDA 1151
- > SQMDA 1136

	Code	Case code	Version	Application
EVO System 65% Transfer	10141559	-	1.30 [EVO]	Dyes
EVO Max. speed	10141560	-	1.40 [EVO]	High gloss finishes. Lacquers
	10141561	-	1.60 [EVO]	High speed finishes
HVLP System 72% Transfer	10141559	-	1.40 [HVLP]	Finishes, dyes
HVLP Minimum mist	10141560	-	1.60 [HVLP]	General finishes
	10141561	-	1.80 [HVLP]	Primers and basecoats
EPA System 65% Transfer	10141562	10141578	1.40 [EPA]	Finishes, dyes
EPA High performance	10141563	10141579	1.60 [EPA]	General finishes
Medium Pressure System 55% Transfer	10141564	10141580	1.80 [EPA]	Primers
64S - 62S Max. spraying	10141572	-	2.20 [64S]	Primers. Waterborne clearcoats
	10141574	-	2.80 [62S]	Gun-applied mastics. Polyester, cast iron effect

INDUSTRIAL PAINTING
Aerographic spray guns
Gravity
spray guns

Classic Pro XD

Maximum ergonomics and comfort

New body design

No joints between air and paint

Internal air distributor

Nozzles and needles in Stainless steel

Chromed Matt

Code	Version
10141620	1.40 [21 EPA] Finishes
10141623	1.60 [21 EPA] Finishes and Primers
10141625	1.80 [21 EPA] Primers and basecoats
10141627	2.00 [25] Thick primers
10141629	2.50 [36] High Viscous
10141630	2.80 [28] Gun applied mastics
10141621	1.40 [HVLP] Finishes
10141624	1.60 [HVLP] Finishes and Primers
10141626	1.80 [HVLP] High thickness
20140831	2.50 [HVLP] High Viscous

475 XTECH

Precision solutions for those small details and retouches

Highest spray quality

Very light injected aluminium body

ATEX II 2G x

Code	Version
20140801	0.50 [05]
20140802	0.80 [05]
20140803	1.00 [10]
20140804	0.50 [R5]

Classic Pro XD Gravity and 475 XTech

The best price/quality ratio in conventional primer spray guns.

A new body with improved ergonomics, the widest range of responses and application solutions and complies with the strictest safety standards and with the strictest standards on solvent emissions, distinguish the new model Classic Pro XD.

Single axis system, minimum parts.

One single piece automatic paint packing gland. No gaskets.

TECHNICAL DETAILS

- > Weight with deposit: 434 g
- > Dimensions: 34.5 x 10 x 18 cm
- > Air inlet coupling thread 1/4" male
- > Maximum air pressure: 8 bar
- > Maximum recommended inlet pressure: 2 bar
- > Maximum recommended application distance: HVLP: max. 12 - 15 cm. 21 EPA y 25/36/28: max. 18 - 20 cm.
- > Maximum paint flow output (nozzle 1.4 mm. 20"): Aircap 21: 143 g/min Aircap HVLP: 202 g/min
- > Air consumption: Aircap HVLP: 355 L/min Aircap 21 EPA: 225 L/min Aircap 25/36/28: 320 L/min



Compact gravity spray gun, due to its small size it is ideal for feathering, small retouches, patches and/or repainting small parts.

Comes with a 125 cc. high quality deposit with paint filter.



R5 Aircap

Large variety of nozzle & needle and solutions

Special aircap R5: to obtain the maximum precision at the finest feathering. Definition and regulation. Similar to an airbrush. Nozzles of 0.5 mm.

05 Aircap: highest quality atomisation for feathering and retouch.

Nozzles & needle 0.5 and 0.8 mm.

10 Aircap: fast and versatile. Metallics and clearcoats. Nozzles & needle 1.0 mm.

TECHNICAL DETAILS

- > Weight with deposit: 330 g
- > Air inlet coupling thread 1/4" male
- > Maximum air pressure: 8 bar
- > Incorporates 100 mesh paint filter
- > Maximum recommended inlet pressure (working pressure): 2.0 - 3.0 bar
- > Air consumption: (at 3.0 bar inlet): Aircap 05: 100 L/min Aircap 10: 110 L/min Aircap R5: 45 L / min



Automatic spray guns

- > **Customised solutions** for each product and spraying process.
- > Maximum **productivity**
- > Optimum **performance**
 - > Minimum mist.
 - > Easy to clean.
- > Maximum **toughness**.
- > **Minimum maintenance**.

These are the basic premises upon which all SAGOLA automatic spray guns are designed.

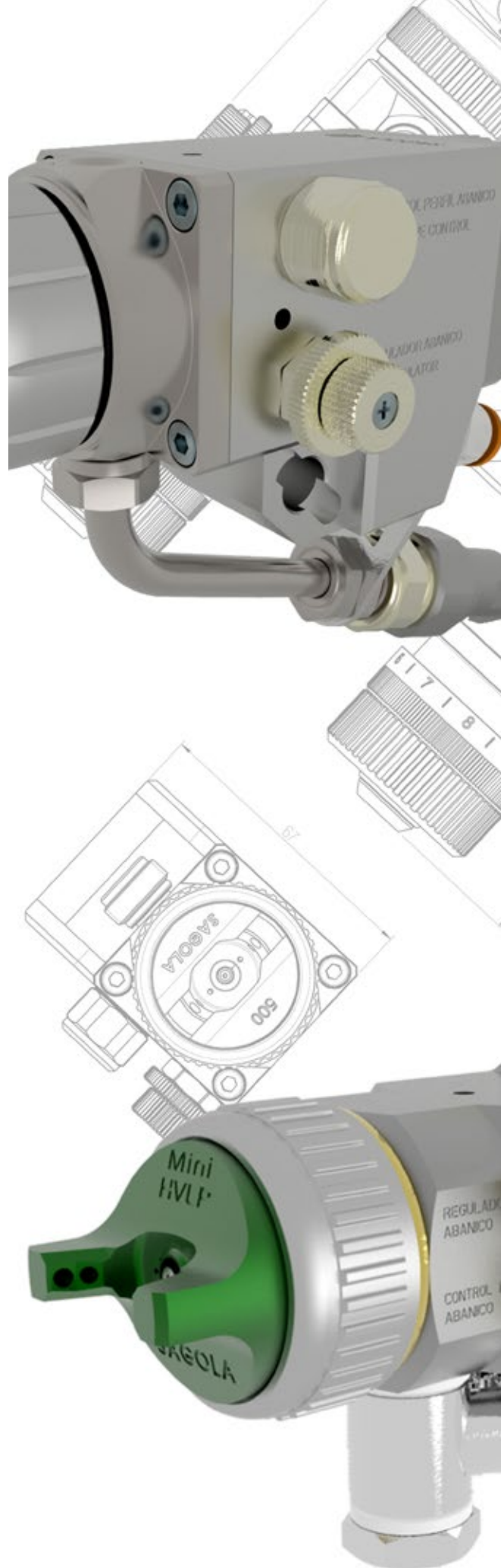

INDUSTRIAL PAINTING

Automatic spray guns

V Series Introduction

New range of automatic spray guns

Totally accurate regulation

New mounting and guidance systems

Significant advantages

The new V series of spray guns incorporates a new system of regulation allowing the achievement of better finishes and higher performance in any kind of application employing any kind of product.

The new V range of automatic spray guns has been designed and manufactured to carry out the very highest quality tasks. This new family of tools aims to cover a wide variety of product applications, including corrosive and abrasive products.

It is designed to work with both waterborne and solvent-based products. Its construction is characterised by the remarkably small number of parts that need maintenance, which makes it extremely reliable, keeping downtime to a minimum.

Versions

The new range embraces all known spray production systems: MEDIUM PRESSURE, HVLP, EPA and MIX.

Each one is available in multiple versions: special for corrosive products, abrasive products, special for robots, etc.

In a word, this new range of spray guns will cover all future production line painting needs.

**INNOVATION + TECHNOLOGY + PERFORMANCE =
MAXIMUM PRODUCTION + MINIMUM MAINTENANCE**

Automatic paint packing gland without gaskets that require handling

Made of stainless steel.

Nozzle and Needle

Made of stainless steel.
Optional Carbide.

Circulating paint outlet

Detachable paint-head

and independent from the pneumatic zone, with four leak detection holes between them, covering all possible angles. 100% stainless steel option.

Paint flow regulator

with integrated adjustable micrometer for a precise and homogeneous paint regulation of all the guns in the line.

Air inlets for atomization and operation

Fan regulator

This regulator allows us to adjust the size of the fan (of the atomisation air).

New mooring and guidance systems

This new system allows removal and replacement of the spray gun from its workstation, keeping always with the same orientation.



Waste time spent adjusting spray guns at their workstations is eliminated completely.

Fan control regulator

This regulator controls the quantity and distribution of air between the lugs and central holes, allowing a perfect distribution of the spray pattern independently of the viscosity of the product.

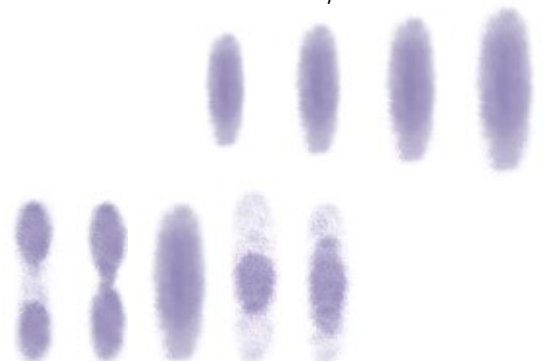

V4 & V5 HVLP V Series

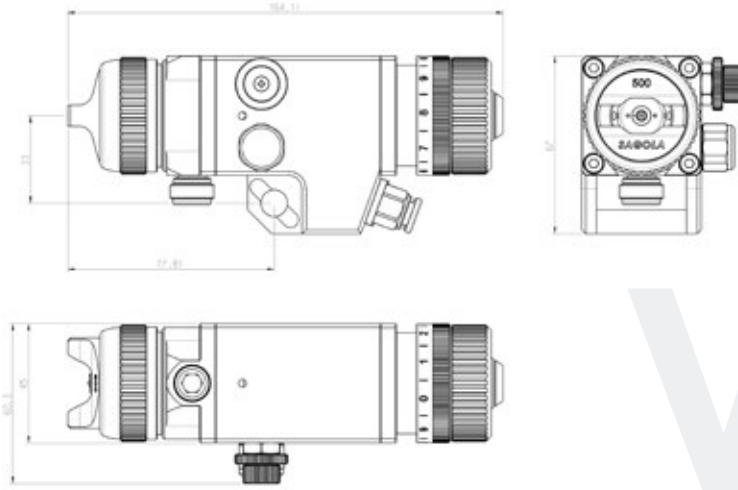

V4



V4

High production conventional spray gun. Incorporates double fan regulator and product regulator.

In the standard version, the nozzle and the needle are made of stainless steel.

Maximum speed of application

Allows working with high paint flows

Stainless steel head versions for corrosive products and tungsten carbide nozzles for abrasives

* See CODES on page 52

Applications

- > For tasks requiring a high opening and closure rate. Ideal to be used with robots and special machinery.
- > Versions for highly corrosive or abrasive products (with tungsten carbide needle and nozzle).
- > Special for high speed and top quality finishes.

Application Sectors

Metal Industry - Plastic Industry - Automotive Industry - Ceramics

TECHNICAL DETAILS

- > Dimensions: 164 x 45 x 104 mm
- > Weight: 785 g
- > Air consumption: 350 - 400 L/min
- > ATEX II 2G x



Standard version

V5



V5 HVLP

Maximum reduction in product consumption and mist

High speed application

Stainless steel head versions for corrosive products and tungsten carbide nozzles for abrasives

* See CODES on page 52

This is the ideal tool where very high application speed along with significant reduction of product consumption are required. Spray mist, pollution, dirt and noise are all greatly reduced, thus improving work conditions.

The high production spray gun incorporates a double spray pattern regulator, product regulator and stainless steel nozzle and needle in the standard version.

Applications

- > For tasks requiring a high opening and closure rate. Ideal to be used with robots and special machinery.
- > Versions for highly corrosive or abrasive products (with tungsten carbide needle and nozzle).

- > For tasks where it is necessary to reduce mist and improve work conditions.
- > Achieves a drastic reduction in product consumption.

Application Sectors

Furniture Industry - Automotive Industry - Plastics - Ceramic - Textile - Tannery

TECHNICAL DETAILS

- > Spray pressure at aircap: 0.68 bar
- > Dimensions: 164 x 45 x 104 mm
- > Weight: 785 g
- > Air consumption: 500 - 600 L/min
- > ATEX II 2G x



INDUSTRIAL PAINTING

Automatic spray guns

V Series V6 EPA & V7 Mix

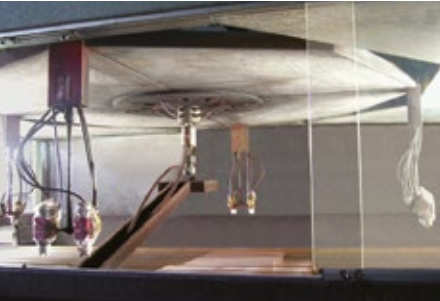

V6

Maximum finish quality with waterborne or solvent-based products

Maximum mist and product consumption reductions

Very low air consumption. Works at very low pressures

* See CODES on page 52

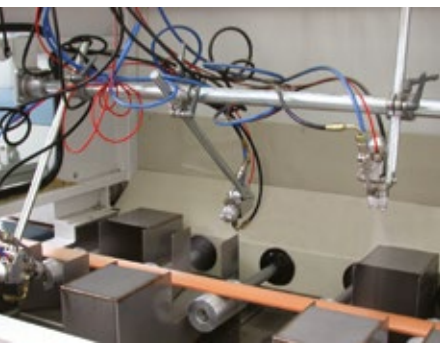

V7 Mix

High production, low pollution

Maximum speed of application

High paint pressure mix system (30-150 bar)

Low air pressure: 0.5 - 2 bar

* See CODES on page 52



EPA spray system with a minimum product transfer of 65%.

Savings of paint supply, reduction of mist.

Stainless steel nozzle and needle, product regulator, double fan regulator....

Applications

- > For tasks requiring a high opening and closure rate. Ideal to be used with robots and special machinery.
- > Versions for highly corrosive or abrasive products (with tungsten carbide needle and nozzle).
- > For tasks where it is necessary to reduce mist and improve work conditions.

- > Achieves a drastic reduction in product consumption.
- > For all applications where the very highest quality finish is required.

Application Sectors

Furniture Industry - Automotive Industry - Plastics Industry - Textiles - Stains

TECHNICAL DETAILS

- > Dimensions: 164 x 45 x 104 mm
- > Weight: 785 g
- > Air consumption: 380 L/min
- > ATEX  II 2G x



The SAGOLA V7 Mix is a high production low pollution spray gun. Tungsten carbide product closure mechanism.

Includes: product inlet filter, air inlet quick couplings, double fan regulator and cleaning and maintenance accessories.

Applications

- > For tasks requiring a high opening and closure rate. Ideal to be used with robots and special machinery.
- > For tasks where it is necessary to reduce mist and improve work conditions.
- > Achieves a drastic reduction in product consumption.

- > Spraying of clearcoats, UV paints, etc.

Application Sectors

Furniture Industry - Metal Industry - Plastic Industry

TECHNICAL DETAILS

- > Working pressure: 30/150 bar
- > Minimum operational pressure: 3.5 bar
- > Dimensions: 164 x 45 x 104 mm
- > Weight: 945 g.
- > Air consumption: 150 L/min
- > ATEX  II 2G x



**INNOVATION + TECHNOLOGY + PERFORMANCE =
MAXIMUM PRODUCTION + MINIMUM MAINTENANCE**

Catalogue 2021

INDUSTRIAL PAINTING

Automatic spray guns

Mini V V Series

Nozzle and Needle

Made of stainless steel.

Automatic paint packing gland without gaskets that require handling

Made of stainless steel.

Product regulator

High precision.

Fan regulator

This regulator allows us to adjust the size of the fan (of the atomisation air).

Fan control regulator

This regulator controls the quantity and distribution of air between the lugs and central holes, allowing a perfect distribution of the spray pattern independently of the viscosity of the product.

TECHNICAL DETAILS

- > Weight: 216 g
- > Dimensions: 32 x 50 x 90 mm
- > Paint inlet: BSP 1/8"
- > Spray air inlet: Ø 8mm
- > Cylinder air inlet: Ø 4mm
- > Air consumption:
 - Mini HVLP: 310 L/min
 - Mlni EPA: 200 L/min
- > ATEX  II 2G x



Mini V

Automatic gun, small size and high precision.

With internal valve

0.3 – 1.80 mm. fluid nozzles.

Mini Xtreme spraying system.

Wide regulation range; paint flow, fan, and pattern shape.

Suitable for small parts painting, and machinery with reduced spaces

HVLP and EPA high transfer aircaps.

Extensions

See options in page 74



HVLP System
75% Transfer

Mini HVLP



EPA System
65% Transfer

Mini EPA



Round Jet System

Mini TECH



EPA System
65% Transfer

Aero Jet



Code **Version**

10210217	0.30 [Mini HVLP]
10210208	0.50 [Mini HVLP]
10210201	0.80 [Mini HVLP]
10210202	1.00 [Mini HVLP]
10210203	1.20 [Mini HVLP]
10210204	1.30 [Mini HVLP]
10210205	1.40 [Mini HVLP]
10210206	1.60 [Mini HVLP]
10210207	1.80 [Mini HVLP]
10210218	0.30 [Mini EPA]
10210216	0.50 [Mini EPA]
10210215	0.80 [Mini EPA]
10210209	1.00 [Mini EPA]
10210210	1.20 [Mini EPA]
10210211	1.30 [Mini EPA]
10210212	1.40 [Mini EPA]
10210213	1.60 [Mini EPA]
10210214	1.80 [Mini EPA]
10210219	0.60 [Mini TECH]
10210220	1.00 [Mini TECH]
10210221	0.50 [Mini Aero JET]



All models in the V series may be customised according to the requirements of the required application. This chart shows standard versions and the optional nozzle and needle combinations with different aircaps and their main features. The data is organised as follows:

	FEATURES	V4 Standard		V5 HVLP		V6 EPA		V7 MIX		
		Code	Version	Code	Version	Code	Version	Code	Version	
STANDARD VERSION	Standard Aluminium head Stainless steel nozzle and needle	10250801	0.80 [765]	10210401	0.80 [500]	10280101	0.80 [380]	35230101	13/40	
		10250802	1.00 [765]	10210402	0.80 [600]	10280102	1.00 [380]			
		10250803	1.00 [777]	10210403	1.00 [500]	10280103	1.20 [380]			
		10250805	1.20 [20]	10210404	1.00 [600]	10280104	1.40 [380]			
		10250806	1.20 [765]	10210405	1.20 [500]					
		10250808	1.20 [797]	10210406	1.20 [600]					
		10250809	1.40 [20]	10210407	1.40 [600]					
		10250810	1.40 [765]							
		10250811	1.80 [20]							
		10250812	0.80 [765]	10210408	0.80 [500]	10280105	0.80 [380]			
		10250813	1.00 [765]	10210409	0.80 [600]	10280108	1.40 [380]			
	Corrosive products Stainless steel head Stainless steel nozzle and needle	10250814	1.00 [777]	10210410	1.00 [500]	10280124	1.80 [380]			
		10250815	1.00 [797]	10210411	1.00 [600]					
		10250816	1.20 [20]	10210412	1.20 [500]					
		10250819	1.20 [797]	10210414	1.20 [600]					
		10250820	1.40 [20]	10210415	1.80 [600]					
		10250821	1.40 [765]							
		10250824	2.80 [62]							
		10250825	1.20 [765]	10210416	1.20 [500]					
		10250827	1.40 [765]	10210418	1.40 [600]					
		10250828	1.80 [67]							
		10250829	2.20 [64]							
	10250830	2.80 [62]								
	ROBOT VERSION	Standard Aluminium head Stainless steel nozzle and needle	10250831	0.80 [765]	10210419	0.80 [500]	10280111	0.80 [380]	35230102	13/40
			10250832	1.00 [765]	10210421	1.00 [500]	10280114	1.40 [380]		
			10250834	1.00 [797]	10210423	1.20 [500]				
			10250835	1.20 [20]	10210424	1.20 [600]				
10250838			1.20 [797]	10210425	1.40 [600]					
10250839			1.40 [20]							
10250840		1.40 [765]								
Corrosive products Stainless steel head Stainless steel nozzle and needle		10250842	0.80 [765]	10210427	0.80 [600]	10280115	0.80 [380]			
		10250844	1.00 [777]	10210430	1.20 [500]	10280116	1.00 [380]			
		10250845	1.00 [797]	10210431	1.20 [600]	10280117	1.20 [380]			
		10250846	1.20 [20]	10210432	1.40 [600]	10280118	1.40 [380]			
		10250848	1.20 [777]	10210433	1.80 [600]					
		10250849	1.20 [797]							
		10250850	1.40 [20]							
		10250851	1.40 [765]							
	10250852	1.80 [20]								
10250853	2.20 [64]									
10250854	2.80 [62]									
Abrasive products Stainless steel head Tungsten Carbide nozzle and needle	10250855	1.20 [765]	10210434	1.20 [500]	10280119	1.20 [380]				
	10250856	1.40 [78]	10210435	1.20 [600]						
	10250857	1.40 [765]	10210436	1.40 [600]						
	10250858	1.80 [67]								
	10250859	2.20 [64]								
	10250860	2.80 [62]								

APPLICATIONS	V4 Standard		V5 HVLP		V6 EPA		V7 MIX	
	Version		Version		Version		Version	
Liquid products. Wood, textile and tannery dyes, Teflon	1.00 [765]		0.80 [500]		0.80 [380]			
			0.80 [600]		1.00 [380]			
			1.00 [500]					
Special for double-coat finishes: metallics and pearls finishes for the automotive and plastics industries	1.00 [777]		0.80 [500]		1.00 [380]			
	1.20 [777]		1.00 [600]		1.20 [380]			
			1.20 [600]					
Special for HS finishes, HS single stage and clearcoats. Auto industry, plastics, wood	1.00 [797]		1.00 [500]		1.20 [380]		0.009	
	1.20 [797]		1.20 [600]				0.001	
Finishes in general: Paints, clearcoats for the wood and metal industries	1.2 [765]		1.00 [500]		1.00 [380]		0.009	
	1.4 [765]		1.20 [500]		1.20 [380]		0.011	
	1.2 [777]		1.20 [600]				0.013	
Primers, basecoats, sealants, fillers for the wood and metal industries	1.2 [765]		1.20 [500]		1.20 [380]		0.013	
	1.4 [765]		1.20 [600]		1.40 [380]		0.015	
			1.40 [600]				0.018	
Abrasive products - ceramic paints - paints for glazing - for the ceramics and vitro-ceramics industries	1.4 [78] C.T.		1.20 [500] C.T.		1.40 [380] C.T.			
	1.8 [67] C.T.		1.20 [600] C.T.					
	2.2 [64] C.T.		1.40 [600] C.T.					
	2.8 [62] C.T.							
Glues, adhesives	1.2 [20]		1.20 [500]		1.40 [380]			
	1.4 [20]		1.40 [600]					
	1.8 [20]							



**450 A HVLP,
4200 A EPA and 4041A**

450 A HVLP

Great product savings

High production version available

Application Sectors

Furniture Industry
Automotive Industry - Plastics Industry - Ceramics

HVLP automatic spray gun which complies with the strictest environmental norms and standards due to its 72% + transfer.

Constructed especially for automatic systems where a very high rate of open - close cycles is required.

It is also recommended where considerable spray mist reduction is required.

Durable: low maintenance costs.

Code	Version	Application
10210303	1.00 [500]	Liquid products, dyes and metallized products
10210304	1.20 [500]	Finishes, basecoats and primers. Metal and wood
10210307	1.20 [600]	High speed application
10210309	1.20 [3030]	Primers, basecoats
10210310	1.40 [3030]	Primers, high micronage, low mist



TECHNICAL DETAILS

- > Air consumption: 540 L/min. (500), 600 L/min. (600), 400 L/min. (3030)
- > Spray pressure at aircap: 0.68 bar
- > Operating pressure: min. 4 bar
- > Dimensions: 152 x 83 x 73 mm
- > Weight: 710 g
- > ATEX II 2G x



4200 A EPA

Lower air consumption than conventional spray guns

Application Sectors

Furniture Industry
Automotive Industry
Plastics Industry

The 4200A is an automatic high production EPA spray gun with a minimum transfer of 65%.

Stainless steel nozzle, needle and paint packing nut.

Extremely high finish quality.

Code	Version	Application
10250701	1.00 [380]	Highest quality finishes
10250702	1.20 [380]	Finishes, primers

TECHNICAL DETAILS

- > Air consumption: 380 L/min.
- > Operating pressure: min. 4 bar
- > Dimensions: 152 x 83 x 73 mm
- > Weight: 710 g
- > ATEX II 2G x



4041A

Special for finishes



Conventional spray gun ideal for robots and special machinery.

Special nozzles in tungsten carbide for abrasive products.

Application Sectors

Metal - Plastic - Automotive - Ceramics

Code	Version	Application
10210350	1.20 [765]	Extremely high finish quality

TECHNICAL DETAILS

- > Air consumption: 370 L/min
- > Dimensions: 152 x 83 x 73 mm
- > Weight: 710 g
- > ATEX II 2G x



INDUSTRIAL PAINTING

Automatic spray guns

Other versions

4041 Mix, V2 PD, 4098 and PSAA 108

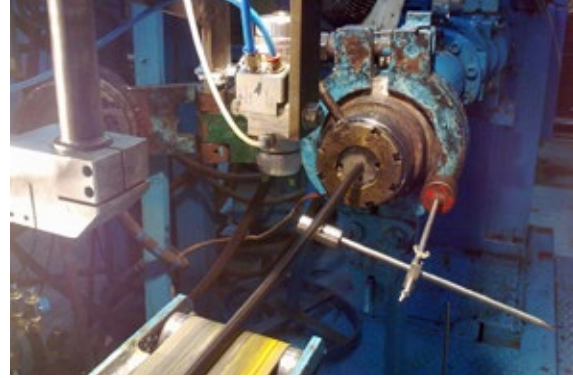

4041 Mix

Maximum speed of application

Medium paint pressure (30-150 bar)

Minimum mist

Code

35230401

Compact and robust automatic mix system spray gun.

Tungsten Carbide closures.

Application Sectors

Furniture - Metal - Wood

TECHNICAL DETAILS

- > Air consumption: 150 L/min.
- > ATEX II 2G x



V2 PD

Maximum transfer

Nozzle 6 mm.

Road signs

Code

10259203

Special automatic spray gun for road signage painting machinery.

Internal mixing nozzle.

Valid for high viscosity products.



4098

Special for clears, ceramics and abrasives

Code

10250601

Version

1.40 [765]

Spray gun designed for the application of ceramic products and abrasive paints.

Product closure is accomplished using a membrane system. Due to its small size and weight it can be installed in places of restricted space.

TECHNICAL DETAILS

- > Dimensions: 70 x 90 x 110 mm
- > ATEX II 2G x



PSAA 108

Automatic airless spray gun

To use with all types of medium and high viscosity products

Code

30270101

Anodized aluminium body. Operation by means of pneumatic cylinder. Tungsten carbide closure.

TECHNICAL DETAILS

- > Maximum product pressure: 400 bar
- > 1/4" product inlet coupling
- > ATEX II 2G x



Industrial Air Filtration Systems

New challenges in painting (new waterborne paints), more tools in the industry and more demanding productivity constantly increase the importance of the **reliability of the compressed air network.**

The appearance of new regulations regarding the drastic reduction of solvents in the new paints means that the existence of impurities in the air system is more and more critical to the final result of satisfactory finishes.

With the sole **objective of achieving the maximum degree of finish** and gloss, we at SAGOLA have applied ourselves wholeheartedly to developing **our 5000X line of filters.**

We have endowed all the models (5000X and 5100X) with the latest purification and regulation technology and performance, offering the industry all the possible responses at the most important point: inside the spray painting booth.

Additionally, SAGOLA offers its **renewed PLUS range of filters, regulators and lubricators** with a new compact, robust design for efficiency and smooth handling, and the best price-quality ratio on the market.



INDUSTRIAL PAINTING
Filtration system
Purifying filter
5000X series

5300X & 5200X filters

5300X

**Coalescent Filter Regulator
 Purifier Filter (0.01 microns)
 + wide surface active charcoal**

**Ideal for waterborne
 and HS paints**

**Solutions for lines with organic
 fumes in the network**

Very high quality finishes

Minimum loss of pressure

Double outlet



Wide surface filtration elements

**Maximum quality of
 manufacturing processes**

Materials and mechanization

**Special for waterborne
 and HS paints**

Maximum flow 2,500 L/min

**Very smooth working
 Maximum precision**

Maximum air filtration quality

**Quick couplings with mechanisms made
 of stainless steel**

Silicone free joints



Code	Model	Version
10730305	5300X	US-Mil
10730351		Nitto
10730308		Euro-profile

Model 5300X offers the maximum filtration level in spray booths and painting lines with high quality air demand.

Ideal for waterborne paint and where organic fumes in the network are a problem.

Sinterised brass 8 micron pre-filtration is incorporated, followed by a 0.01 micron coalescent filter and final filtration by a wide surface active charcoal filter.

In addition to water and impurities, this process eliminates organic fumes and foul air.

TECHNICAL DETAILS

- > Air flow: 2,500 L/min
- > Air inlet: 1/2" BSP
- > Air outlet: 1/4" BSP
- > Maximum working pressure: 12 bar
- > Maximum temperature resistance 90°C
- > Automatic + 2 semi-automatic drain systems



5200X

Code	Model	Version
10730304	5200X	US-Mil
10730350		Nitto
10730307		Euro-profile

Network pressure = 7 bar (101.53 psi)

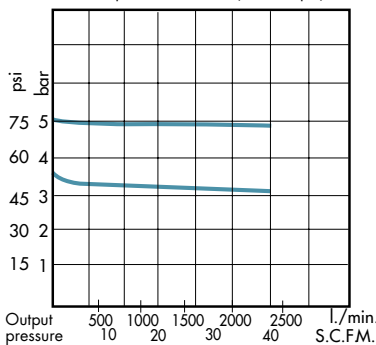

Model 5200X offers the highest technology for air filtration. It incorporates an 8 micron sinterised brass filter, followed by a final 0.01 micron coalescent filter.

Other characteristics are the automatic drain system and the regulator with regulation wheel.

Its NEW VESSELS are tougher and more protective.

Its NEW DRAINING SYSTEM reduces maintenance costs due to its greater durability. It carries out double filtration with optimum flow and pressure regulation, retention of water and impurities attaining an air purity of 99%.

TECHNICAL DETAILS

- > Air flow: 2,500 L/min
- > Air inlet: 1/2" BSP
- > Air outlet: 1/4" BSP (USMil couplings)
- > Maximum working pressure: 12 bar
- > Maximum temperature resistance 90°C
- > Automatic + semi-automatic drain system



5100X & 5000X filters

5100X

Valid for HS paints and highest quality finishes

Regulator filter with new vessel

Minimum pressure loss

Double outlet

Code	Model	Version
10730202	5100X	US-Mil
10730208		Nitto
10730206		Euro-profile

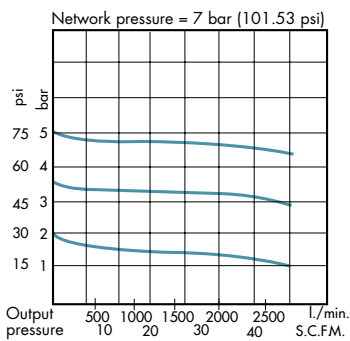

Air purifying filter with pressure regulator and pressure gauge.

Its NEW VESSEL is tougher and more protective.

Model 5100X comes with a NEW DRAINING SYSTEM which reduces maintenance costs due to its greater durability.

It incorporates an 8 micron sinterised brass filter.

Air-assisted regulator. Wide surface filtration elements. Maximum manufacturing quality in materials and machining

Special for waterborne and HS paints

Extremely smooth action. Maximum precision.

Maximum quality in air filtration.

Push connectors with stainless steel mechanisms and silicone-free gaskets. Automatic-draining system and air assisted regulator.



TECHNICAL DETAILS

- > Air flow: 2,500 L/min.
- > Air inlet: 1/2" BSP
- > Air outlet: 1/4" BSP
- > Maximum working pressure: 12 bar
- > Maximum temperature resistance: 90°C



5000X

Valid for highest quality finishes

Code	Model	Version
10730204	5000X	US-Mil
10730207		Nitto
10730205		Euro-profile

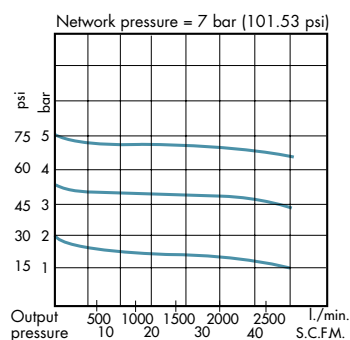

Air purifying filter with pressure regulator and pressure gauge.

Its NEW VESSEL is tougher and more protective.

The 5000X model incorporates a semi-automatic draining system.

TECHNICAL DETAILS

- > Air flow: 2,500 L/min.
- > Air inlet: 1/2" BSP
- > Air outlet: 1/4" BSP
- > Maximum working pressure: 12 bar
- > Maximum temperature resistance: 90°C



INDUSTRIAL PAINTING

Filtration system

Purifying filter

4000 series

4120 Plus and 4220 Plus filters



4120

4120 PLUS

Effective solution for compressed air filtration in professional paint booths

Effective solution for compressed air filtration in professional paint booths for: car refinish, wood, machinery, plastics and industry in general.

Highly reliable air regulation system. Manufactured from a solid aluminum block.

It eliminates air, oil and particles. Friction and centrifugal filtration. Automatic drain of condensed liquids.

High air flow. High quality manometer.



Code	Model	Version
10730501	4120	-
10730502	4120 PLUS (includes coupling)	US-Mil
10730503		Nitto
10730504		Euro-profile

TECHNICAL DETAILS

- > Dimensions 4120: 279 x 117 x 69.5 mm.
- > Dimensions 4120 PLUS: 279 x 117 x 96 mm.
- > Weight: 4120: 1,015 g. 4120 PLUS: 1,220 g.
- > Brass filter: 20 microns
- > Drain system: automatic
- > Air flow: 1,700 l/min.
- > Maximum pressure: 12 bar
- > Air inlet: 1/2"
- > Coupling 4120 PLUS: SAGOLA US Mil



4220

4220 PLUS

Recommended for last generation finishes

Two stage air filter. Maximum filtering level. Recommended for last generation finishes. Waterborne paints, HS clearcoats and enamels, high gloss lacquers

Highly reliable air regulation system. Manufactured from a solid aluminum block.

1st stage: water, oil and particles filtering + 2nd stage: submicronic filtering. 0.01 microns Automatic drain of condensed liquids. High air flow. High quality manometer.



Code	Model	Version
10750401	4220	-
10750402	4220 PLUS (includes coupling)	US-Mil
10750403		Nitto
10750404		Euro-profile

TECHNICAL DETAILS

- > Dimensions 4220: 279 x 117 x 162 mm.
- > Dimensions 4220 PLUS: 279 x 117 x 186 mm.
- > Weight: 4220: 1,797 g. 4220 PLUS: 2,002 g.
- > Brass filter: 20 microns + Coalescent filter: 0.01 microns
- > Drain system: automatic + semi automatic
- > Air flow: 1,700 l/min.
- > Maximum pressure: 12 bar
- > Air inlet: 1/2"
- > Coupling 4220 PLUS: SAGOLA US Mil



**479 Plus, 970 Plus, 430 Plus,
439 Plus and 437 Plus**

**479
PLUS**

The most compact solution for the small workshops, industry or priming and preparation areas

Code	Version
10730401	1/2"
10730402	3/8"
10730403	1/4"



TECHNICAL DETAILS

- > Dimensions: 229 x 73 x 115 mm
- > Weight: 886 g
- > Brass filter: 40 microns
- > Air flow: 1,700 L/min
- > Couplings: 1/2", 3/8", 1/4"
- > Max. working pressure: 10 bar
- > Draining system: semi-automatic



Large air flow, highly reliable regulating system, high quality pressure gauge, the best materials. Adaptable to any size of hose. Great filtration capacity with check window for waste particle and semi-automatic drain system.

**970
PLUS**

Assure the supply of clean and properly lubricated air to tools and pneumatic engines

Code	Version
10750301	1/2"
10750302	3/8"
10750303	1/4"



TECHNICAL DETAILS

- > Dimensions: 229 x 148 x 115 mm
- > Weight: 1,450 g
- > Brass filter: 40 microns
- > Air flow: 1,700 L/min
- > Connections: 1/2", 3/8", 1/4"
- > Max. working pressure: 10 bar
- > Draining system: semi-automatic



It supplies clean, lubricated air to all your tools. Accurate control of the oil content by means of a "drop-by-drop" hand regulator.

**430
PLUS**

Small, sturdy, reliable and long lasting



Code	Version
10740501	1/2"
10740502	3/8"
10740503	1/4"

Mini air regulator. Diaphragm regulator from 0 to 10 bar.

TECHNICAL DETAILS

- > Dimensions: 107 x 65 x 115 mm
- > Weight: 544 g
- > Air flow: 1,200 - 1,700 L/min
- > Couplings: 1/2", 3/8", 1/4"
- > Max. working pressure: 10 bar



**439
PLUS**

High durability, maximum robustness



Code	Version
10720401	1/2"
10720402	3/8"
10720403	1/4"

High flow filter for insertion in air lines. Check window for waste liquids. Semi-automatic drain system.

Suitable for all type of installations, accessories included.

TECHNICAL DETAILS

- > Dimensions: 158 x 73 x 73 mm
- > Weight: 553 g
- > Brass filter: 40 microns
- > Air flow: 1,700 L/min
- > Couplings: 1/2", 3/8", 1/4"
- > Max. working pressure: 10 bar
- > Draining system: semi-automatic



**437
PLUS**

Minimum flow restrictions



Code	Version
10710301	1/2"
10710302	3/8"
10710303	1/4"

Ideal for the proper lubrication of pneumatic tools. Manual oil regulator by level check window, drop by drop system. CNC mechanized from a solid aluminium block.

TECHNICAL DETAILS

- > Dimensions: 165 x 73 x 73 mm
- > Weight: 482 g
- > Oil filter
- > Air flow: 1,920 L/min
- > Couplings: 1/2", 3/8", 1/4"
- > Max. working pressure: 10 bar



INDUSTRIAL PAINTING

Filtration system

Air treatment

Air quality test equipment

Filter accessories and complements

Air quality test equipment

Easy to use

High precision

Code

15020001

Code

Version

Code	Version
49000740	Membrane filter kit, pore 0.45 (50 units)

Equipment for the detection of air impurities, humidity level and temperature.

It incorporates air quality test equipment with inlet regulator, flashlight with magnifying glass of 30 magnification for visualization of impurities, humidity meter and digital temperature.

It incorporates membrane filter kit, pore 0.45 (50 pcs).



ACCESSORIES AND COMPLEMENTS Air filtration systems

Sinterised brass filter kit (1 unit)

Optimum service life: 6 months
5100X filter

Code

56418719



Timer for filters (5000X series)

The Time Indicators offer a helpful visual reminder of maintenance programs of our filters. The timer is included in each kit filter.

- 3-month timer
- 6-month timer



Optional Double outlet Kit

Quick couplings SAGOLA US Mil series. Models: 4120, 4220, 5000X, 5050X.

Code

56418704



Automatic drain

Models: 4120, 4220, 5100X

Code

56450010



Spare part for air filter-regulator

5000X filter

Code

56418720



Filtro de bronce sinterizado 20 micras

Modelo 4120 PLUS y 4220 PLUS

Code

56418721



Coelescent filter 0.01 microns

4220 and 4220 PLUS filter

Code

56418722

Vessel Kit + Automatic drain

4000 series

Code

56417711

Version

4120 PLUS

56417712

4220 PLUS

Semi-automatic drain valve

4000 series

Code

56417507

Pressure gauge

5000X series

Code

54550016



Gasket Kit

4000 series

Code

56418587

Version

4120 PLUS

56418588

4220 PLUS

Anti-static air hoses

See "Compressed Air Complements" (page 65)



Filter 4000 range Display

4000 series

Code

70000007



Compressed air hoses Compressed air complements

- > **Wide range of push connectors and plugs:**
 - US MIL, EURO PROFILE, MULTI PROFILE and NITTO
 - High quality, safety, anti-shock....
 - > **Air and Paint Hoses**
 - > **High and low pressure hoses**
 - > For mix, airless and aerographic spray guns

SAGOLA invests the maximum care in this range because we know that you can not take risks with pressure equipment.

General application spray guns

A wide range of **pneumatic tools** as a **complement to the paint line** in industrial workshops:

- > **Blowers and Sealants.**
- > Guns for **adhesives bead** application and textured products.

Sanding system

Low air consumption pneumatic rotary orbital sanders.

- > Work with the maximum cleanliness, assuring that all the sanding dust is properly collected.

Personal Protection

Protective masks for sanding and painting processes, anti-static painters' overalls...

One of SAGOLA's main concerns is to assure optimum, safe working conditions for all.

Waste Management System

Why increase waste disposal costs of paint cans, paper and cardboard because you can not reduce their volume?

We at SAGOLA understand the importance of proper management of the residues generated by paints and solvents in industry and the high costs these imply in the running of a business. In this section we offer two important product lines to drastically reduce these costs.

- > **Can, paper and cardboard crushers**
 - Robust
 - Safe and easy to use



INDUSTRIAL PAINTING

Compressed air
Compressed air
complements

Quick couplings and connectors

FEATURES
NEW RANGE

Couplings and connectors



Max. pressure: 25 bar
Europerfil max. pressure: 15 bar
Aluminum plugs max. pressure: 20 bar

The new range of plugs SAGOLA presents cutting-edge design. SAGOLA offers a wide range that gives cover 100% of market requirements. Is incorporated security versions. All steel and aluminum plugs are BSP; Males (BSPT) and females (BSPP).

Plug body made of treated steel and valve made of brass. So a guaranteed life of more than 1,500,000 uses. The new range of plugs SAGOLA incorporates a handle made of composite, which gives a high resistance to both attrition and drag. Attrition resistance tested in more than 48,000 impacts and the equivalent to a crawl 12 km.

1. SHOOTER made of composite with a weight reduction and extraordinary durability against impact (48,000 impacts test).

2. BODY PLUG made of steel with anticorrosive treatment.

3. VALVES Brass valve manufactured, specific to work at high temperatures.

4. JOINTS Nitrile Butadiene. Operating temperature range: -20°C +100°C.

5. PINS made of tempered high strength steel that guarantees the absence of attrition.

6. SPRING made of stainless steel.



The quick couplings are supplied in individual blister packs

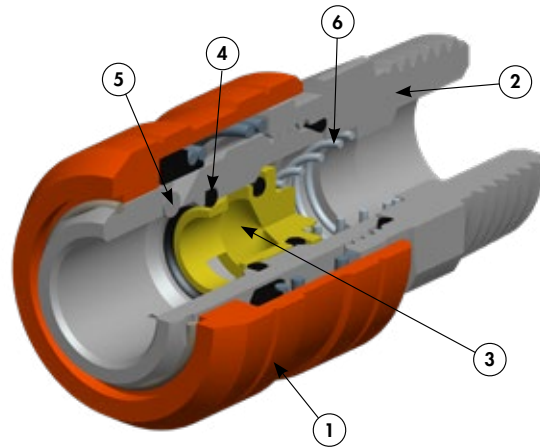

Ultra-Light range. Ultra-light weight. 45 g.

US-Mil range

ULTRA LIGHT

Quick coupling. US-Mil RANGE
Flow: 68 m³/h. - 1,133 L/min.
Body and shooter made of high strength aluminum. Valve made of brass. Pins made of high strength steel.
Air coupling: 1/4"



Code	Version
11010531	BSPT 1/4"



Code	Version
11010431	BSPP 1/4"



Code	Version
11010629	Barb. 8 mm.

US-Mil range

Air coupling: 1/4" Flow: 68 m³/h. - 1,133 L/min.

Quick coupling. US-Mil RANGE
Simple shutter plug, made of hardened steel with gasket made of Nitrile Butadiene. Its excellent sealing prevent dirt penetrates inside. High strength sleeve.



Code	Version
11010524	BSPT 1/4"
11010525	BSPT 3/8"
11010526	BSPT 1/2"



Code	Version
11010424	BSPP 1/4"
11010425	BSPP 3/8"
11010426	BSPP 1/2"



Code	Version
11010624	Barb. 8 mm.
11010625	Barb. 10 mm.

Code	Version
11010527	BSPT 1/4"

25 units

Code	Version
11010427	BSPP 1/4"

25 units

Code	Version
11010626	Barb. 8 mm.

25 units

US-Mil range

Safety Plug

Air coupling: 1/4" Flow: 68 m³/h. - 1,133 L/min.

Quick coupling. US-Mil RANGE
Plug with gasket made of Nitrile Butadiene and double effect opening. Anti-whiplash safety plug according to ISO-4414. Two movements "push-pull" to disconnect.
High strength sleeve.



Code	Version
11010528	BSPT 1/4"
11010529	BSPT 3/8"
11010530	BSPT 1/2"



Code	Version
11010428	BSPP 1/4"
11010429	BSPP 3/8"
11010430	BSPP 1/2"



Code	Version
11010627	Barb. 8 mm.
11010628	Barb. 10 mm.



Quick couplings and connectors

Euro-Profile range

Air coupling: 7.6 mm. Flow: 85 m³/h. - 2,000 L/min.

Quick coupling

Euro Profile RANGE

Simple shutter plug, made of hardened steel with gasket made of Nitrile Butadiene. Its excellent sealing prevent dirt penetrates inside.



Code	Version
11010823	BSPT 1/4"
11010824	BSPT 3/8"
11010825	BSPT 1/2"



Code	Version
11010723	BSPP 1/4"
11010724	BSPP 3/8"
11010725	BSPP 1/2"



Code	Version
11010924	Barb. 8 mm.
11010923	Barb. 10 mm.

Euro-Profile range

Safety Plug

Air coupling: 7.6 mm. Flow: 85 m³/h. - 2,000 L/min.

Quick coupling

Euro Profile RANGE

Plug with gasket made of Nitrile Butadiene and double effect opening. Anti-whiplash safety plug according to ISO-4414. Two movements "push-pull" to disconnect. High strength sleeve.



Code	Version
11011323	BSPT 1/4"
11011324	BSPT 3/8"
11011325	BSPT 1/2"



Code	Version
11011423	BSPP 1/4"
11011424	BSPP 3/8"
11011425	BSPP 1/2"



Code	Version
11011523	Barb. 8 mm.
11011524	Barb. 10 mm.

Multi-Profile range

3x1 system. Compatibility: US-MIL/EUROPROFILE/ITALIANO PROFILE

Quick coupling

Multi-Profile RANGE

Flow: 85 m³/h. - 2,000 L/min. Simple shutter plug, made of steel with gasket made of Nitrile Butadiene. Its excellent sealing prevent dirt penetrates inside. Air coupling: 8 mm.



Code	Version
11010826	BSPT 1/4"
11010827	BSPT 3/8"



Code	Version
11010726	BSPP 1/4"
11010727	BSPP 3/8"



Code	Version
11010925	Barb. 8 mm.
11010926	Barb. 10 mm.

Nitto range

ASIA-PACIFIC MARKET EXCLUSIVE PROFILE

Quick coupling

Nitto RANGE

Flow: 85 m³/h. - 2,000 L/min. Simple shutter plug, made of steel with gasket made of Nitrile Butadiene. Its excellent sealing prevent dirt penetrates inside. Air coupling: 8 mm.



Code	Version
11011701	BSPT 1/4"
11011702	BSPT 3/8"



Code	Version
11011801	BSPP 1/4"
11011802	BSPP 3/8"



Code	Version
11011901	Barb. 8 mm.
11011902	Barb. 10 mm.

US-Mil range

Brass Plug

Quick coupling

US-Mil RANGE-Spec C-4109

600 L/min. Versatile. Simple blocking plug made of brass with Buna N gasket. Its excellent sealing avoids the penetration of impurities to the inside. Fully compatible with earlier lines of SAGOLA plugs.



Code	Version
11010520	BSPT 1/4"
11010521	BSPT 3/8"
11010522	BSPT 1/2"



Code	Version
11010420	BSPP 1/4"
11010421	BSPP 3/8"
11010422	BSPP 1/2"



Code	Version
11010621	Barb. 8 mm.
11010622	Barb. 10 mm.

Code	Version
11010523	BSPT 1/4"

25 units

Code	Version
11010423	BSPP 1/4"

25 units

Code	Version
11010623	Barb. 8 mm.

25 units

INDUSTRIAL PAINTING

Compressed air
Compressed air
complements

Quick Couplings, Threaded Couplings

FEATURES

Couplings and connectors

SIZE 2

The size 2 plug is the most commonly used push plug in paint and body shops, and also in industry for the connection of all kinds of pneumatic tools Silicone free. All springs, valves and pins made of stainless steel. All SAGOLA connectors are manufactured in high carbon steel making them extremely strong and stress resistant.

US-Mil range

Connector without blocker, made of steel.

Quick coupling

US-Mil-Spec C-4109 RANGE (2 units) ID 5.5 mm.
Fully compatible with earlier lines of SAGOLA plugs. Made of high-carbon steel. Anti-corrosive nickel etched finish. Connector without blocker.



Code	Version
11020420	BSPT 1/4"
11020421	BSPT 3/8"
11020422	BSPT 1/2"



Code	Version
11020520	BSPP 1/4"
11020521	BSPP 3/8"
11020522	BSPP 1/2"



Code	Version
11020621	Barb. 8 mm.
11020622	Barb. 10 mm.

Code	Version
11020423	BSPT 1/4"
50 units	

Code	Version
11020524	BSPP 1/4"
50 units	

Code	Version
11020623	Barb. 8 mm.
50 units	

Orientable quick coupling with exclusive rotating dial system, for greater freedom of movement.



Code	Version
11020523	BSPP 1/4"
Orientable	



Euro-Profile range

Maximum performance and durability in high production workshops.

Quick coupling

Euro Profile RANGE (2 units) High flow. ID 7-8 mm. Made of high-carbon steel. Anti-corrosion blue galvanized finish. Connector without blocker.



Code	Version
11020710	BSPT 1/4"
11020721	BSPT 3/8"
11020722	BSPT 1/2"



Code	Version
11020810	BSPP 1/4"
11020821	BSPP 3/8"
11020822	BSPP 1/2"



Code	Version
11020921	Barb. 8 mm.
11020922	Barb. 10 mm.

Nitto range

ASIA-PACIFIC MARKET EXCLUSIVE PROFILE

Quick coupling

Nitto RANGE (2 units) High flow. ID 7-8 mm. Made of high-carbon steel. Anti-corrosion blue galvanized finish. Connector without blocker.



Code	Version
11021001	BSPT 1/4"
11021002	BSPT 3/8"



Code	Version
11021101	BSPP 1/4"
11021102	BSPP 3/8"



Code	Version
11021201	Barb. 8 mm.
11021202	Barb. 10 mm.

Threaded couplings

Connection coupling

(2 units) High flow. Made in brass. Anticorrosive treatment.

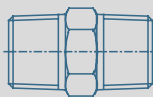

Code	Version
11000101	BSPT 1/4" M - M
11000102	BSPT 1/2" M - M
11000103	BSPT 3/8" M - M



Code	Version
11000106	BSPP 1/2" F at 3/8" M
11000107	BSPP 3/8" F at 1/4" M
11000108	BSPP 3/8" M at 1/4" F

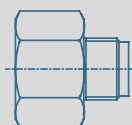

Code	Version
11000104	BSPT 1/2" M at 3/8" M
11000105	BSPT 3/8" M at 1/4" M
11000112	BSPT 1/2" M at 3/8" F
11000113	BSPT 1/2" M at 1/4" F

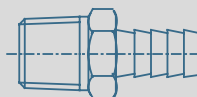

Code	Version
11000109	BSPT 1/2" M at Barb. 8 mm.
11000110	BSPT 3/8" M at Barb. 8 mm.
11000111	BSPT 1/4" M at Barb. 8 mm.



Air hose



**Anti-static
compressed air
hose**

Ideal for painting in
the booth

Light, flexible and
manageable

Twist free

Anti-static EPDM rubber hose with exterior textile reinforcement. Ideal for painting in the booth.

High security crimped ends able to bear the high temperatures of the booth. No need to use flanges, avoiding that they release or cause leaks due to dilation.

Code	Version
56414014	2.5 m. 6x12 mm. F/F 1/4"
56414024	6 m. 8x15 mm. F/F 1/4"
56414025	11 m. 8x15 mm. F/F 1/4"
56414027	16 m. 8x15 mm. F/F 1/4"
56414026	26 m. 8x15 mm. F/F 1/4"

TECHNICAL DETAILS

- > Working temperature: -40°C to +120°C.
- > Working pressure: 20 bar
- > Breaking strain 80 bar
- > Anti-stick exterior
- > Internal diameter 8 mm. Valid for to be used with HVLP high flow guns
- > Meets Regulation 97/23/CE
- > 1/4" H couplings with conical closure and flare fitting for easy assembly of the push connector
- > Conducting pipe < 1 MΩ
- > Max. temperature: 120°C
- > Tough (breaking strain 80 bar)



100 m. roll of hose

Multi-use hose

Meets Regulation
97/23/CE

Code

52450008

Multi-use thermo rubber hose with Polyester outer reinforcement. Compact with excellent performance and oil resistance.



TECHNICAL DETAILS

- > 8 x 15 mm. air hose in 100 metre rolls
- > Thermal cork hose with exterior polyester reinforcement
- > Working pressure: 20 bar
- > Breaking strain 60 bar
- > Working temperature: -15°C to +60°C

INDUSTRIAL PAINTING
 General applications
 General applications guns

Pressure adhesives
Classic S1 and Classic S1 Venturi blow guns

Adhesives
Pressure

For bead application of white glues and adhesives



Code
10151401

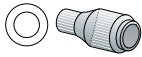

- (Ø1) SCOLAS - SG418030
- (Ø2) SCOLAS - SG418026
- (Ø3) SCOLAS - SG418027

Especially for bead applications of glues and adhesives. White glue application for the wood industry.

Teflon-coated body makes cleaning easy. Incorporates a series of 1 and 2 mm. caps and product flow regulator.

The 3 mm. aircap, scoring aircap (to mark lines) and 4-aperture aircap (to apply glue to cavities) can be acquired as options.

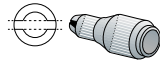

(Ran) SCOLAS - SG418029

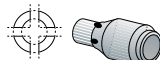

(Ø4) SCOLAS - SG418028



Classic S1

Blowgun
 Made of aluminum
 Light and robust

Code	Version
20340601	Metallic aircap
20340604	With extension
20340603	Plastic aircap

- Three versions of the blow gun Classic S1:
- Classic S1 with metallic aircap.
 - Classic S1 with extension.
 - Classic S1 with plastic aircap.

Blowgun with body built in aluminum. Light but robust.

Classic S1
 Metallic aircap



Classic S1
 With extension

Classic S1
 Plastic aircap

TECHNICAL DETAILS

- > Plastic/metallic/extension aircap
- > Weight: 187/190/198 g
- > 1/4" male coupling
- > Air consumption: 240 L/min at 6 bar (air inlet pressure)
- > Working pressure: 3 bar - 10 bar
- > Maximum pressure: 10 bar

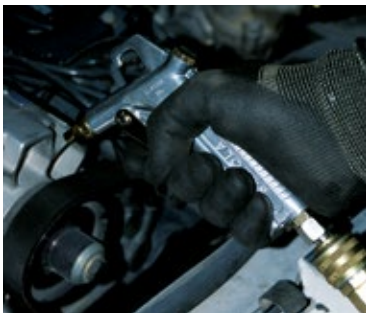

Classic S1 Venturi

Blowgun made of aluminum

Venturi System

High Air flow

Code

20340605

TECHNICAL DETAILS

- > Metallic Aircap
- > Weight: 225 g
- > 1/4" male coupling
- > Air consumption: 240 L/min. at 6 bar (air inlet pressure)
- > Air outlet: 925 L/min. at 6 bar
- > Working pressure: 3 bar - 10 bar
- > Maximum pressure: 10 bar



518 Pro and 416

**518
 PRO**

Code

10330301

Total regulation on product flow and spray size

Operating pressure



Pressurized pneumatic gun for antigravel cartridges and underbody protection.

Total regulation on product flow and quality of atomization and spray size. Air inflow regulator. Operating pressure. The cartridge container is made in anodized aluminum. It is light and sturdy. Needle regulator to control precisely the texturing. Very accurate depressurizing valve. It is easy to handle even with gloves.

Special air cap for cavity wax, that includes two types of dispensers. (OPTIONAL). Stainless steel silencer.

The 518 Pro works with low pressure and offers the maximum regulation options and productivity.



TECHNICAL DETAILS

- > Empty weight: 1,369 g
- > Connection: 1/4" male coupling
- > Air consumption: 120 L/min at 3.5 bar air pressure
- > Working pressure: 2 bar - 4 bar
- > Maximum pressure: 10 bar

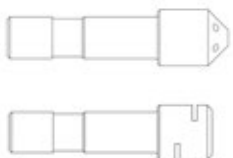

Rosette nozzle

Nozzle 360°

Nozzle Kit + Spray gun adapter

Code

56418705

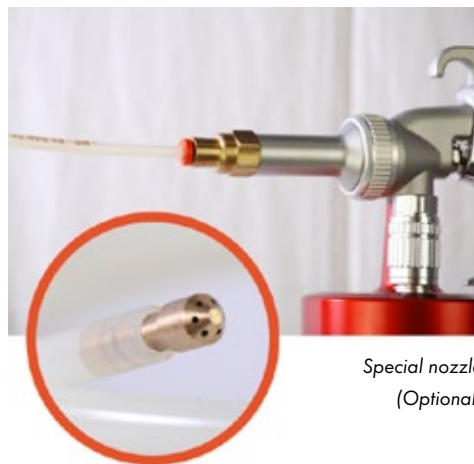

Special nozzle (Optional)

416

Screwed directly to the cartridge

Operation by suction

Adjustable metallic aircap

Code

20330401

Pneumatic gun for antigravel cartridges and underbody protection. Operation by suction. Gun for the application of standardized acoustic insulation 1 L. cartridges. To be screwed directly to the cartridge. Adjustable metallic aircap to control the quantity and texture of the product.

TECHNICAL DETAILS

- > Empty weight: 520 g
- > Connection: 1/4" male coupling
- > Air consumption: 160 L/min at 3.5 bar air pressure
- > Working pressure: 3 bar - 10 bar
- > Maximum pressure: 10 bar



INDUSTRIAL PAINTING
 General applications
 Pneumatic
 sealer gun

**Selladora 3900 Plus
 and 3900 Plus M4/6**

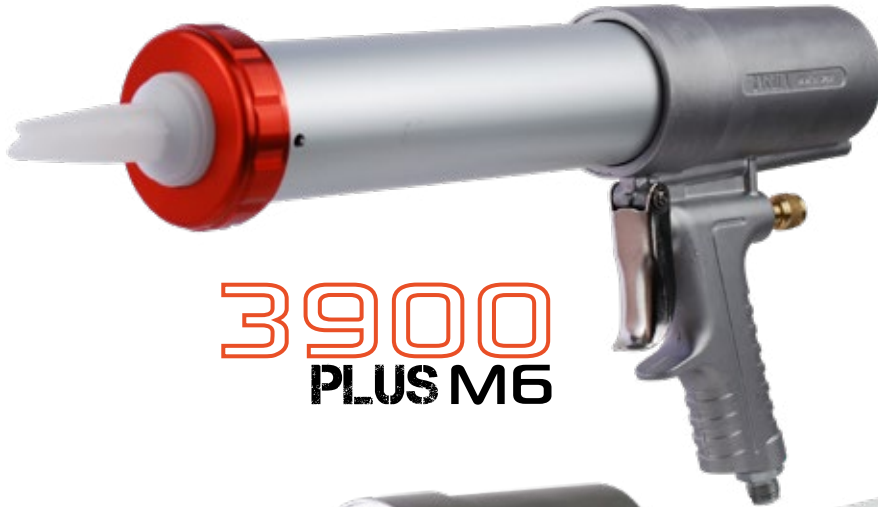

**3900
 PLUS M6**



**3900
 PLUS M4**



**3900
 PLUS**

Sturdy aluminum body

Quick Closing

Metal air distributor

Discharge valve

1/4" Standard Connection

The new 3900 Plus pneumatic sealers are a compact, efficient and light solution for everyday needs in any workshop. These pneumatic guns are very useful when it comes to structure assembling, repairs and windshield set-ups, amongst others.

There are two versions: the 3900 Plus for sealants in cartridges and the 3900 Plus M for sealants in sausages. Both versions include a trigger with discharge valve, which guarantees a great precision and control.

The metallic internal parts assure a long working life. Besides, those parts do not require any manipulation neither any maintenance.

Its body is made of high resistance aluminum. The front part on the 3900 Plus is made of non-deformable plastic.

The 3900 Plus sealers are a very strong product capable to work for long working hours.

3900 Plus
 Code

10330201

3900 Plus M4
 Code

10330401

3900 Plus M6
 Code

10330402

TECHNICAL DETAILS 3900 PLUS - CARTRIDGE

- > Front part made in plastic.
- > Bead application of sealers and silicone in 300 ml. cartridges.
- > 1/4" Air inlet
- > Weight: 540 g / Length: 250 mm
- > Working pressure: 4 - 6 bar
- > Discharge valve to shut-off the product outlet when releasing the trigger.

TECHNICAL DETAILS 3900 PLUS M - SAUSAGE

- > Front part made in anodized aluminum.
- > Bead application of sealers and silicone in sausage:
 - 300 & 400 ml. **3900 PLUS M4**
 - 600 ml. **3900 PLUS M6**
- > 1/4" Air inlet
- > **3900 PLUS M4:** Weight: 560 g / Length: 250 mm
- > **3900 PLUS M6:** Weight: 570 g / Length: 320 mm
- > Working pressure: 4 - 6 bar
- > Discharge valve to shut-off the product outlet when releasing the trigger.



Profiled composite casing:
comfortable and long-lasting

High performance
sanders

Extremely
high finish quality

Light, compact
and powerful

No surface
contamination

L505

Sander designed for
grinding and fast sanding

L252

Sander for
high quality finishes

Code L505

40000232

Code L252

40000231

L252R

Sander for
fine finishes

Code L252R

40000230



The air outlet is spins 360°

The air can be oriented and kept
away from the use

Fitted for extraction, it is easily
connected to central or portable
extraction systems

"L" range sanders

"L" range sanders have been designed for workshops where high performance and top quality finishes are demanded. If you are looking for scratch-free quality, you can trust the "L" range. Due to the lubricant-free design, there is no concern about substrate contamination.

0.2 HP motor, 12,000 r.p.m.

The **L505** is a pneumatic orbital sander with a 5 mm. oscillation designed for quick grinding down, with a good quality surface finish.

The **L252** is a pneumatic orbital sander with an oscillation of 2.5 mm. which ensures high quality finishes without leaving any kind of marks on the surface.

TECHNICAL DETAILS

- > Plate size: 152 mm./6 inch
- > Oscilation L505: 5 mm. L252: 2.5 mm.
- > Free speed: 12,000 r.p.m.
- > Net weight: 0.87 Kg.
- > Total length: 118 mm.
- > Air consumption: 220 L/min.
- > Air inlet: 1/4"
- > Min. size hose: 8 mm.

The **L252R** is a pneumatic orbital sander which ensures precision sanding and top quality finishing. It is ergonomic and light, perfect for those small retouches.

TECHNICAL DETAILS

- > Plate size: 75 mm./3 inch
- > Oscilation L252R: 2.5 mm.
- > Free speed: 12,000 r.p.m.
- > Net weight: 0.84 Kg.
- > Total length: 110 mm.
- > Air consumption: 220 L/min.
- > Air inlet: 1/4"
- > Min. size hose: 8 mm.

Sand disks

Code	Version
49000220	Ø 75 mm. sand disk (Velcro) L252R
49000501	Ø 152 mm. sand disk (Multiholes, Velcro) L252, L505

Catalogue 2021

INDUSTRIAL PAINTING

Sanding systems

Pneumatic
sanders

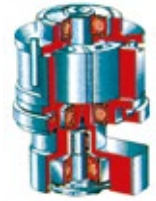

Composite impellers and rotor Lubrication-free,
works without oil. Counterweight system to
guarantee smooth operation.



INDUSTRIAL PAINTING
 Personal protection
 Breathing mask

Complete breathing equipment 4240 and Mask MP 300



Face Mask 4240

Full breathing equipment
 Maximum protection

Complete breathing equipment which includes: belt, pocket regulator and coalescent filter to remove low levels of moisture and oil. 10 meters of hose and safety plugs, 1,5 meter of hose spray gun outlet.

Preset regulator incorporating flow warning gauge with integrated high efficiency coalescent filter. Carbon filter to absorb vapour and odour.

The unit conforms to BS EN 1835, with a protection factor of 40. EC Certificate Number 58459, issued by BSi Product Certification.

89/686/CEE (EPI) approved.

Code	Version
15830101	US-Mil*
15830102	Nitto*

*Hose kit included: 10 meters of hose and safety plugs, 1.5 meter of hose spray gun outlet.

Code	Version
15830103	US-Mil
15830104	Nitto

Does not include hose kit



Hose kit

Each of the built-in chemical filters of the mask is classified as "filter against fumes, A type, class 1" according to EN 141, and are also certificated separately.

Approved
 EN 140:1998
 EN 143:2000/A1:2006
 EN 14387:2004+A1:2008

MP300

Mask with double charcoal filter against organic and solvent fumes

Facial housing of thermoplastic rubber

Elastic tape fastener

Double air inlet, allowing higher flow inhalations, making easier to breathe.

Antiallergic. The mask is fitted with two carbon filters and a exhaling valve.

Suitable to be used in atmospheres contaminated with fumes and vapours with a boiling point over 65°C, like solvents and paints, offering a proper protection (with oxygen content in the air over 17% in volume).



Code
14810301

SPARE Paint filter against organic and solvent fumes. 10 units.

Code
56418052





FFP2 masks, MP2 mask and Antistatic Coverall



M210 Model

M200 Model

Masks FFP2

Self-filtering paper masks

Code	Version
40000263	M200
40000264	M210 with valve

For solid and liquid particles of low and medium toxicity. For use against non-ferrous metal dust, welding metal fumes, gasses and mists NOT INCLUDING materials such as lead, aluminium and manganese.

Double elastic tape. Flexible metallic strip for adjustment to nose, area.

NPF (nominal protection factor): 12 (concentration permitted in the atmosphere 12 times the TLV)

TECHNICAL DETAILS

M200 Model

> Comes in a 20-unit box.

M210 Model

> Comes in a 10-unit box.

> Built-in exhalation valve to make breathing easier.

Classic MP2

Mask with double charcoal filter against organic and solvent fumes

Facial housing of thermoplastic rubber

Elastic tape fastener

Code
14810201

SPARE Paint filter against organic and solvent fumes. 10 units.

Code
56418052

Double air inlet, allowing higher flow inhalations, for easier breathing.

Each of the built-in chemical filters of the mask is classified as "filter against fumes, A type, class 1" according to EN 141, and are also certificated separately.

79 mm. diameter cylinder shape filter.

Approved:
EN 140:1998
EN 143:2000/A1:2006
EN 14387:2004+A1:2008



TECHNICAL DETAILS

> Breathing resistance:

To air Flow 25 x 2 L/min

To inhalation: 0.52 mbar

To exhalation: 1.64 mbar

> To continuous flow inhalation:

30 L/min flow: 0.11 mbar

95 L/min flow: 0.33 mbar

> CO2 content (death space): 0.60%

> Escapes to the interior (hermeticity): < 2

Antistatic Coverall

Air ventilation system

Breathable

Water repellent and dirt-resistant

Code	Size	EU size
40000523	XS	38/40
40000524	S	42/44
40000525	M	46/48
40000526	L	50/52
40000527	XL	54/56
40000528	2XL	58/60
40000529	3XL	62/64

Breathable panel in the back and underarms.

Adjustable hood with elastic band and velcro. Press-buttons neck closure. Elastic ankle and wrist.

2-way zip and flap fitted with 2 breast pockets, 1 inside pocket, 2 side pockets and a hip pocket.

Original Dupont Teflon coating (water repellent and dirt-resistant).

Silicone and lint free.

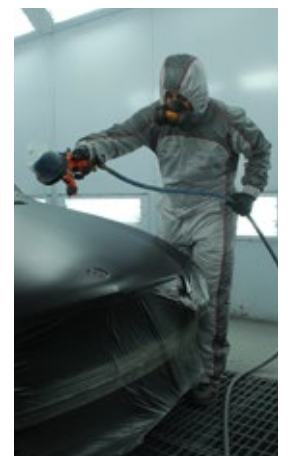

TECHNICAL DETAILS

> Material: 98% polyester, 2% carbon

> Standard EN1149: 1 Permanent antistatic

> PPE CAT. I

> Washable at 30°C or by chemical cleaning

Can and carton crusher

Can Crusher

Simple, versatile and efficient

Code

40000314

Meets European Directive 98/37/CEE of 22 January 1998.

Significant space saving and cost reduction in waste management.



Designed to solve residue storage and disposal problems in places like bodyshops, industrial workshops, garages, etc.

Can Crusher

Greater load. Valid for cylindrical recipients up to 25 L (maximum height 45 cm. and 31 cm. diameter).

TECHNICAL DETAILS

- > Dimensions: 510 x 540 x 1,460 mm
- > Working pressure: 8 bar
- > Power: above 1,700 Kg
- > Pneumatic safety system
- > Total weight: 185 Kg

Can and carton crusher

Functional and complete

Code

40000315

Meets European Directive 98/37/CEE of 22 January 1998.

Significant space saving and cost reduction in waste management.

Designed to solve residue storage and disposal problems in places like bodyshops, industrial workshops, garages, etc.



Two accesses:

- > Upper: loads cardboard and paper.
- > Lower: unloads cardboard, loads cans.

Reel of string at rear to tie the crushed bundles of paper and cardboard.

TECHNICAL DETAILS

- > Dimensions: 560 x 750 x 1,750 mm
- > Working pressure: 8 - 9 bar
- > Pneumatic safety system
- > Total weight: 225 Kg

Industrial and construction application guides, aircaps, nozzles and spray gun and pump accessories

Service, a key word in SAGOLA's
strategic approach to bodyshop.

One of our main concerns is to make the painter
be able to quickly identify and acquire the main
SAGOLA original spare parts - nozzles, needles,
aircaps, racks, deposits, regulators...

In this section we offer our application guides
and our main complements.

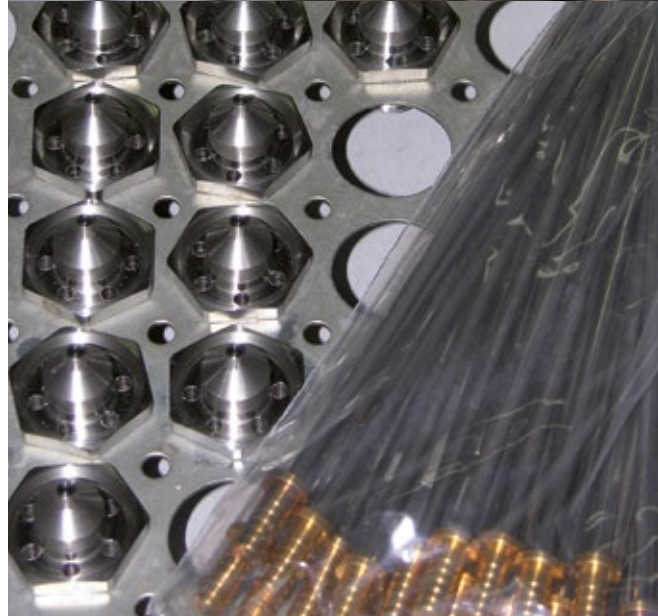
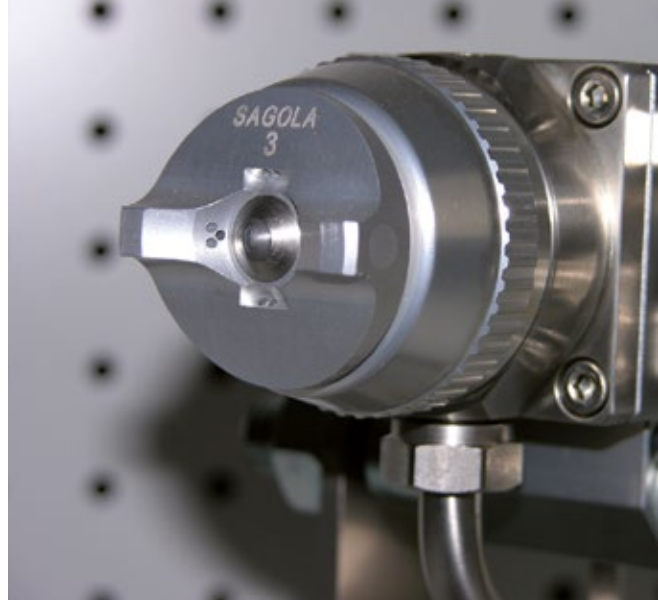

Extensions for spray guns

Extension for X 4100 series

Versions extension for X 4100 series spray gun.
150, 300 and 500 mm. extensions for a variety of needles.

Code	Description
52411737	Extension 150 mm. 1.00 - X 4100 series
52411738	Extension 150 mm. 1.20 - X 4100 series
52411733	Extension 150 mm. 1.40 - X 4100 series
52411740	Extension 300 mm. 1.00 - X 4100 series
52411741	Extension 300 mm. 1.20 - X 4100 series
52411742	Extension 300 mm. 1.40 - X 4100 series
52411743	Extension 500 mm. 1.20 - X 4100 series
52411744	Extension 500 mm. 1.80 - X 4100 series

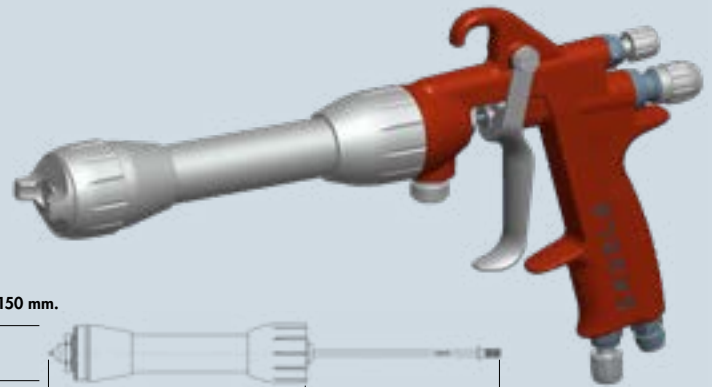

Extension 150 mm.

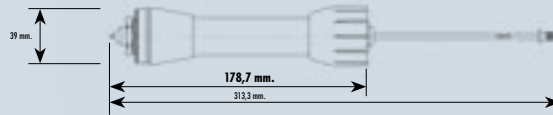

Extension 300 mm.

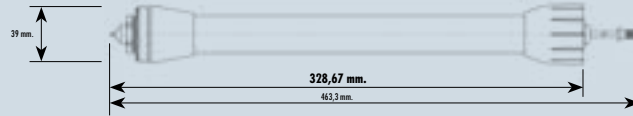

Extension 500 mm.

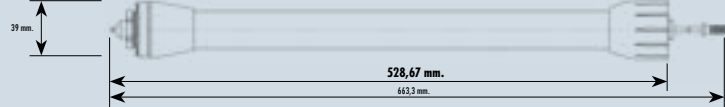

Extension for MiniXtreme

Versions extension for Mini Xtreme spray gun.
150 and 300 mm. extensions for a variety of needles.

Code	Description
52411713	Extension 150 mm. 0.80 MiniXtreme
52411714	Extension 150 mm. 1.00 MiniXtreme
52411715	Extension 150 mm. 1.20 MiniXtreme
52411716	Extension 150 mm. 1.40 MiniXtreme
52411717	Extension 300 mm. 0.80 MiniXtreme
52411718	Extension 300 mm. 1.00 MiniXtreme
52411719	Extension 300 mm. 1.20 MiniXtreme
52411720	Extension 300 mm. 1.40 MiniXtreme

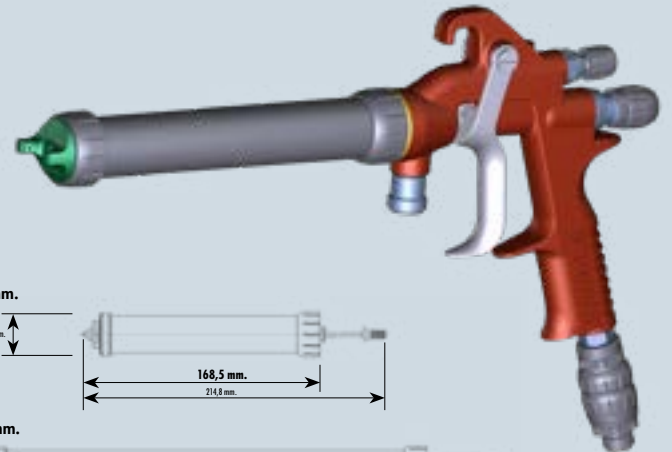

Extension 150 mm.

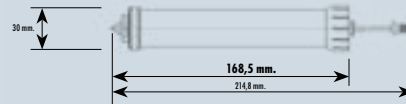

Extension 300 mm.

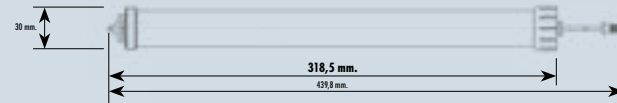

Extension for Mini V

Versions extension for Mini V automatic spray gun.
300 mm. extensions for a variety of needles.

Code	Description
52411730	Extension 300 mm. 1.20 Mini V
52411731	Extension 300 mm. 1.30 Mini V



Extension 300 mm.



Lateral jet aircap

Mini V series

Code

56411117



Lateral jet aircap

X 4100 series

Code

56418621





Spray Gun Accessories

Air flow regulators



Code
56418020

Flow regulator with pressure gauge RC1

Aluminium, very light. Ideal for high transfer HVLP and EPA spray guns
Red-to-green pressure scale (green within provisions of regulations).
Assembled in seconds with hermetic hand tightening.



Code
56418519

High precision flow regulator

High precision air-flow regulator kit.
Solvent-proof gaskets. Suitable for 4600 Xtreme digital.
Recommended for finishing spray guns.



Code
40000335

Flow regulator RC2

Pressure gauge flow regulator.
Exact input pressure gun.
High quality gauge green scale for high transfer guns.

Ford 4 viscosimeter

Code
56418001

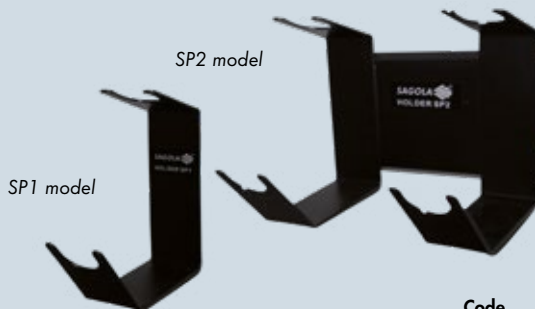

Magnetic Stands SP1 and SP2
Magnetic stand for 1 (SP1) or 2 (SP2) spray guns. Solvent-proof paint. Supports PPS type adapters. Maximum robustness. High holding power due to two powerful magnets.

Code	Version
40000245	SP1
40000246	SP2



Gravity spray gun Pressurizer kit

for gravity spray guns. Gravity cup pressure kit for high viscosity materials spraying. Non-return valve included.

Code
56418513

Accessories for cleaning and maintenance



Cleaning kit

Complete cleaning set, including one brush for outside cleaning, and rods of different sizes for all the inner paths of the spray gun. Supplied in a practical show case.

Code
40000086



Lubricant grease

Natural grease, specially made for spray guns and painting equipments moving parts lubrication. High consistency, even under extreme temperatures. Long lasting, it doesn't lose properties over the time. Easy to open 100 ml. can.

Code
56418589

Gravity deposits

High quality deposits for gravity spray guns.

Code	Description	Spray Gun Range
56418432	0.65 L Gravity Deposit Kit	4600 Xtreme / 4500 Xtreme
56418084	0.65 L Gravity Deposit Kit	X series / 4100 Xtreme / 3300 GTO / Classic PRO XD
56418085	0.65 L Gravity Deposit Kit - without filter	X series / 4100 Xtreme / 3300 GTO / Classic PRO XD
56418420	0.65 L Gravity Deposit Kit	Classic LUX Gravity
56418080	0.50 L Gravity Deposit Kit	Mini Xtreme Gravity
49000430	0.60 L Gravity Deposit Kit	Junior G
56418081	0.125 L Gravity Deposit Kit	Mini Xtreme Gravity / 475 XTECH
56418079	0.200 L Gravity Deposit Kit	Mini Xtreme Gravity / 475 XTECH
56418431	0.120 L Gravity Deposit Kit	474
56418099	0.125 L Gravity Deposit Kit - black	Special Ultra Violet - Mini Xtreme Gravity
56418505	1 L Gravity Deposit Kit	4600 Xtreme / 4500 Xtreme
56418082	1 L Metallic Gravity Deposit Kit	X series / 4100 Xtreme / 3300 GTO



Product filter kit

Product filter kit for gravity spray guns.

Code	Description	Spray Gun Range
56418017	10 Product Filter Kit (Gravity) 0.65 L	4100 Xtreme / 3300 GTO / Classic PRO XD
56418438	10 Product Mini-Filter Kit (Gravity)	4600 Xtreme / 4500 Xtreme
56418059	10 Product Filter Kit (Gravity) 0.50 L	Mini Xtreme Gravity
56418061	6 Product Filter Kit (Gravity) 0.125 L	Mini Xtreme Gravity
56418479	5 Product Filter Kit (Gravity)	474



Couplings

for disposable deposits

Code	Description	Spray Gun Range
55711612	Coupling 3M PPS	X 4100 series / 3300 GTO / Mini XTREME
55711616	Coupling MIPA / CARWOX	X 4100 series / 3300 GTO / Mini XTREME
55711614	Coupling GERSON / NORTON	X 4100 series / 3300 GTO / Mini XTREME
55711615	Coupling FLEXI CUP	X 4100 series / 3300 GTO / Mini XTREME
55711618	Coupling Devilbiss / DEKUPS	X 4100 series / 3300 GTO / Mini XTREME
55711620	Coupling SATA RPS	X 4100 series / 3300 GTO / Mini XTREME
55711623	Coupling COLAD	X 4100 series / 3300 GTO / Mini XTREME



Suction Deposit, gaskets and filters

Code	Description	Spray Gun Range
56418074	Suction Deposit Kit 1 L	X 4100 series / Classic PRO XD / Classic LUX
56418076	Suction Deposit Kit 0.5 L (403/435)	403 / 435
56418014	10 Product Filter Kit (Suction)	X 4100 series / Classic PRO XD / Classic LUX
56418013	5 Suction Spray Gun Anti-drip Lid Kit	X 4100 series / Classic PRO XD / Classic LUX
56418509	Deposit Closure Flanged Washer	X 4100 series / Classic PRO XD / Classic LUX



Other kits and accessories

Air valve, paint packing, joints,...

Code	Description	Spray Gun Range
56418445	Air Valve Kit	X 4100 series / Xtreme
56418514	Air Valve Kit	Mini Xtreme
56418481	Air Valve Kit	3300 GTO / Classic PRO XD / Classic LUX
56411616	Paint Packing Nut	4600 Xtreme / 4500 Xtreme / 4300 / X 4100 series
56418034	Paint Packing Nut. Needle + Product	Mini Xtreme
56418441	Air Gasket Replacement Kit (6 units)	4600 Xtreme / 4500 Xtreme / Mini Xtreme
56418494	Air Gasket Replacement Kit (6 units)	3300 GTO / Classic PRO XD / Classic LUX
49000422	Air Valve Kit	Junior G
49000425	Paint Packing Nut	Junior G
56418449	Air Valve Kit	474
56418452	Paint Packing Nut	474
56418703	Close Gasket Replacement Kit	518 PRO



The **aircap model** is vital to achieve the desired results. The type of product we are going to apply and the application system we are going to use must both be taken into account when selecting an aircap. Correctly combining the aircap with the adequate nozzle and needle kit, the desired spray quality will be obtained.

High transfer aircaps

Code	Aircap	Spray gun range	Transfer System	Application	Nozzle+ Needle mm.	Air consumption L/min. (2 bar)	Flow g/min.	Fan size mm.
56418565	XT01	X 4100 Series GRAVITY/SUCTION	EPA 65% Transfer	Maximum performance, Clearcoats, Basecoats and metallized	1.3 - 1.8	315	175	305
56418566	XT03		HVLP 75% Transfer	Maximum atomisation quality and minimum mist. 0.7 bar at aircap	0.8 - 1.6	460	180	310
56418564	XT01 B	X 4100 Series PRESSURE	EPA 65% Transfer	High gloss pressure finishes	0.8 - 1.4	380	*	*
56418572	3030		HVLP 75% Transfer	Finishes and primers. Maximum mist reduction. 0.7 bar at aircap	1.2 - 2.2	420	*	*
56418524	MINI AQUA	Mini Xtreme GRAVITY/PRESSURE	EPA 65% Transfer	Special Spot Repair, painting of parts. Basecoats, clearcoats and waterborne paints	0.8 - 1.2	190	110	230
56418525	MINI EPA	Mini Xtreme GRAVITY/PRESSURE	EPA 65% Transfer	Finishes: maximum quality spray with significant saving of material	0.8 - 1.4	200	155	260
56418526	MINI HVLP		HVLP 75% Transfer	Maximum transfer, great saving of material with minimum air consumption	0.8 - 1.4	310	150	250
56418560	MINI VIT	Mini Xtreme PRESSURE	EPA 65% Transfer	High speed application. Wide fan patterns	0.8 - 1.4	350	*	*
56418558	GTO EVO	3300 GTO	EPA 65% Transfer	High gloss finishes, basecoats	1.3 - 1.6	255	175	280
56418645	GTO EPA		EPA 65% Transfer	Finishes and primers. Minimum air consumption	1.4 - 1.8	250	160	245
56418552	GTO HVLP		HVLP 75% Transfer	Finishes and fillers. Minimum mist, maximum savings. 0.7 bar at aircap	1.4 - 1.8	360	145	295
56418639	21 EPA	CLASSIC PRO XD	EPA 65% Transfer	Fillers, Primers. Maximum performance	1.4 - 1.8	225	143	285
56418643	HVLP		HVLP 75% Transfer	Fillers, Primers. Minimum mist, maximum saving. 0.7 bar at aircap	1.4 - 1.8	355	202	250

Conventional Spray Aircaps

Code	Aircap	Spray gun range	Transfer System	Application	Nozzle+ Needle mm.	Air consumption L/min. (2 bar)	Flow g/min.	Fan size mm.
56418573	96	X 4100 Series GRAVITY/SUCTION	Medium Pressure 55% Transfer	Finishes: high quality, high speed	1.3 - 1.8	250	178	295
56418575	645			Waterborne clearcoats and clears. High micronage. Glues, adhesives	2.2	290	310	280
56418574	625			X 4100 Series GRAVITY	High viscosity. Polyester for spray guns, cast iron effect. Enamels, ceramics	2.8	340	400
56418571	765	X 4100 Series PRESSURE	Medium Pressure 55% Transfer	Pressure finishes. Wide fan patterns	1.0 - 1.8	315	*	*
56418576	777			Maximum atomising power, high gloss finishes. Basecoats	0.8 - 1.4	345	*	*
56418568	67			Ceramic products, silicates, abrasives	1.8 CT	400	*	*
56418570	64			High micronage, large nozzles	2.2 - 2.5	390	*	*
56418567	62			High viscosity products	2.8	410	*	*
56418569	20			Glues, adhesives	1.2 - 1.8	430	*	*
56418640	25			CLASSIC PRO XD	Conventional 50% Transfer	Thick primers	2.0	155
56418642	36	Intermediate coats, thick products, glues	2.5			240	263	240
56418641	28	High viscosity, gun-applied mastics, cast iron effect	2.8			205	249	230
56418246	05	475 XTECH	Conventional 50% Transfer	Feathering	0.5 - 0.8	100	60	140
56418247	10			Parts coating, retouches	1.0	110	90	160
56418271	R5			High precision round pattern. Feathering and fine sign-writing	0.5	45	38	15-100

* Outlet flow and fan size on a pressure spray gun will depend on the viscosity of the paint, the diameter and length of the paint hose, and the paint pressure setting on the pump equipment.



Nozzle + Needle Kit

Code	Description	Spray gun range	Code	Description	Spray gun range	
10011251	Nozzle + needle kit 0.8 - 41 series	X 4100 Series GRAVITY SUCTION* PRESSURE	10011187	Nozzle + needle kit 1.4	CLASSIC PRO XD GRAVITY SUCTION	
10011252	Nozzle + needle kit 1.0 - 41 series		10011180	Nozzle + needle kit 1.6		
10011253	Nozzle + needle kit 1.2 - 41 series		10011191	Nozzle + needle kit 1.8		
10011121	Nozzle + needle kit 1.3 - 41 series		10011181	Nozzle + needle kit 2.0		
10011122	Nozzle + needle kit 1.4 - 41 series		10011182	Nozzle + needle kit 2.2		
10011123	Nozzle + needle kit 1.6 - 41 series		10011183	Nozzle + needle kit 2.5		
10011155	Nozzle + needle kit 1.6S - 41 series*		10011188	Nozzle + needle kit 2.8	475 XTECH	
10011124	Nozzle + needle kit 1.8 - 41 series		10011198	Nozzle + needle kit 1.0		
10011125	Nozzle + needle kit 2.0 - 41 series		10011197	Nozzle + needle kit 0.8		
10011126	Nozzle + needle kit 2.2 - 41 series		10011195	Nozzle + needle kit 0.5		
10011127	Nozzle + needle kit 2.5 - 41 series		4100 XTREME GRAVITY	10011196	Nozzle + needle kit 0.5 CHR	450 A 4200 A
10011128	Nozzle + needle kit 2.8 - 41 series			1001221	Nozzle + needle kit 0.8	
10010129	Nozzle + needle kit 1.2 CT - 41 series		4100 XTREME SUCTION PRESSURE	1001222	Nozzle + needle kit 1.0	
10010130	Nozzle + needle kit 1.4 CT - 41 series			1001223	Nozzle + needle kit 1.2	
10010131	Nozzle + needle kit 1.5 CT - 41 series	1001224		Nozzle + needle kit 1.4		
10010132	Nozzle + needle kit 1.8 CT - 41 series	1001226		Nozzle + needle kit 1.8		
10010133	Nozzle + needle kit 2.2 CT - 41 series	1001230		Nozzle + needle kit 2.0		
10010134	Nozzle + needle kit 2.8 CT - 41 series	10010156		Nozzle + needle kit 1.2 CT		
10011100	Nozzle + needle kit 0.8 - 40 series	4100 G 4200 4300		10010157	Nozzle + needle kit 1.4 CT	
10011101	Nozzle + needle kit 1.0 - 40 series			10010158	Nozzle + needle kit 1.5 CT	
10011102	Nozzle + needle kit 1.2 - 40 series			10010159	Nozzle + needle kit 1.8 CT	
10011103	Nozzle + needle kit 1.3 - 40 series			10010160	Nozzle + needle kit 2.2 CT	
10011104	Nozzle + needle kit 1.4 - 40 series			10010161	Nozzle + needle kit 2.8 CT	
10011106	Nozzle + needle kit 1.6 - 40 series			4100 XTREME SUCTION PRESSURE	1001207	Nozzle + needle kit 0.8
10011107	Nozzle + needle kit 1.8 - 40 series				1001208	Nozzle + needle kit 1.0
10011119	Nozzle + needle kit 2.0 - 40 series				1001209	Nozzle + needle kit 1.2
10011108	Nozzle + needle kit 2.2 - 40 series		1001210		Nozzle + needle kit 1.4	
10011109	Nozzle + needle kit 2.5 - 40 series		1001211		Nozzle + needle kit 1.6	
10011120	Nozzle + needle kit 2.8 - 40 series	1001212	Nozzle + needle kit 1.8			
10010145	Nozzle + needle kit 1.2 CT - 40 series	4100 G 4200 4300	10010123		Nozzle + needle kit 1.2 CT	
10010146	Nozzle + needle kit 1.4 CT - 40 series		10010124		Nozzle + needle kit 1.4 CT	
10010147	Nozzle + needle kit 1.5 CT - 40 series		10010125		Nozzle + needle kit 1.5 CT	
10010148	Nozzle + needle kit 1.8 CT - 40 series		10010126		Nozzle + needle kit 1.8 CT	
10010149	Nozzle + needle kit 2.2 CT - 40 series		10010127	Nozzle + needle kit 2.2 CT		
10010150	Nozzle + needle kit 2.8 CT - 40 series		10010128	Nozzle + needle kit 2.8 CT		
10011200	Nozzle + needle kit 0.8 - Mini series		MINI XTREME 403	56418150	Nozzle + needle kit 0.8	
10011201	Nozzle + needle kit 1.0 - Mini series			56418151	Nozzle + needle kit 1.0	
10011202	Nozzle + needle kit 1.2 - Mini series			56418152	Nozzle + needle kit 1.2	
10011203	Nozzle + needle kit 1.3 - Mini series			56418153	Nozzle + needle kit 1.4	
10011204	Nozzle + needle kit 1.4 - Mini series	56418154		Nozzle + needle kit 1.8		
10011205	Nozzle + needle kit 1.6 - Mini series	564181501		Nozzle + needle kit 1.2 CT		
10011206	Nozzle + needle kit 1.8 - Mini series	564181502		Nozzle + needle kit 1.4 CT		
10011187	Nozzle + needle kit 1.0 - 3300 series	3300 GTO 3300 PRO 3200		564181503	Nozzle + needle kit 1.8 CT	
10011180	Nozzle + needle kit 1.2 - 3300 series			564181504	Nozzle + needle kit 2.2 CT	
10011191	Nozzle + needle kit 1.3 - 3300 series			564181505	Nozzle + needle kit 2.8 CT	
10011181	Nozzle + needle kit 1.4 - 3300 series		10011218	Nozzle + needle kit 0.3		
10011182	Nozzle + needle kit 1.6 - 3300 series		10011247	Nozzle + needle kit 0.5		
10011183	Nozzle + needle kit 1.8 - 3300 series		10011240	Nozzle + needle kit 0.8		
10011188	Nozzle + needle kit 2.0 - 3300 series		10011241	Nozzle + needle kit 1.0		
10011192	Nozzle + needle kit 2.2 - 3300 series		10011242	Nozzle + needle kit 1.2		
10011189	Nozzle + needle kit 2.5 - 3300 series		10011243	Nozzle + needle kit 1.3		
10011190	Nozzle + needle kit 2.8 - 3300 series		10011244	Nozzle + needle kit 1.4		
10011370	Nozzle + needle kit + aircap 1.6	CLASSIC LUX GRAVITY	10011245	Nozzle + needle kit 1.6		
10011371	Nozzle + needle kit + aircap 1.8		10011246	Nozzle + needle kit 1.8		
10011372	Nozzle + needle kit + aircap 2.0		10011219	Nozzle + needle kit 0.5 Aerojet		
10011373	Nozzle + needle kit + aircap 2.5		10011248	Nozzle + needle kit 0.6 CHR		
10011374	Nozzle + needle kit + aircap 1.6		CLASSIC LUX SUCTION	10011249	Nozzle + needle kit 1.0 CHR	
10011375	Nozzle + needle kit + aircap 1.8					

Nozzle + Needle Kit

Code	Description	Spray gun range
20010148	Nozzle + needle kit 2.0	CLASSIC SMOOTH
20010149	Nozzle + needle kit 2.5	
20010145	Nozzle + needle kit 1.4	CLASSIC LUX PRESSURE
20010147	Nozzle + needle kit 1.8	
10011231	Nozzle + needle kit 1.0	455 HVLP
10011232	Nozzle + needle kit 1.2	
10011233	Nozzle + needle kit 1.4	
10011234	Nozzle + needle kit 1.8	
10011236	Nozzle + needle kit 2.2	
10011237	Nozzle + needle kit 2.5	
10011376	Nozzle + needle kit 0.8	474
10011377	Nozzle + needle kit 1.0	
20010112	Nozzle + needle kit 2.2	4001
20010113	Nozzle + needle kit 2.8	
20010114	Nozzle + needle kit 3.2	
20010115	Nozzle + needle kit 4.0	
10011378	Nozzle + needle kit 2.8	4022
10011379	Nozzle + needle kit 3.2	
49000431	Nozzle + needle kit 1.4	JUNIOR G
49000432	Nozzle + needle kit 1.6	
49000433	Nozzle + needle kit 1.8	

**Nozzle and Needle fitting Kit**

High pressure spray guns.
MIX/AIRLESS

Code	Description	Spray gun range
10011250	Nozzle and Needle fitting Kit + Joints	MINI XTREME MIX
30010013	Nozzle and Needle fitting Kit + Joints	PSAM 107 PSAA 108
56418230	Nozzle and Needle fitting Kit	PSAM 104
56418406	Nozzle fitting Kit + Needle head	V7
56418405	Nozzle fitting Kit + Needle head	4041 MIX



INDUSTRY APPLICATION GUIDE

GRAVITY SPRAY GUNS

	MODELS	X 4100 Series Gavity		
		AIRCAPS		
		Transfer / System		
		X 4100 Series G 55% / Medium Pressure	X 4100 Series EPA 65% / EPA	X 4100 Series HVLP 75% / HVLP
INDUSTRIAL BODYSHOP	Fillers	1.6 - 1.8 [96]	1.6 - 1.8 [XT01]	1.6 - 1.8 [XT03]
	Basecoats		1.3 - 1.4 [XT01]	1.4 [XT03]
	Clearcoats	1.4 - 1.6 [96]	1.4 [XT01]	
	Single stage paints and HS	1.6 [96]	1.4 - 1.6 [XT01]	
METAL INDUSTRY	Primers	1.6 - 1.8 [96]		1.8 [XT03]
	Paints and Clears	1.4 - 1.6 [96]	1.4 - 1.6 [XT01]	
	Thick coats			2.2 - 2.8 [64S/62S]
	Silicates and abrasives	2.2 CT - 2.8 CT [64S/62S]		1.8 CT - 2.5 CT [3030]
WOOD INDUSTRY	Dyes	1.2 - 1.3 [96]	1.2 - 1.3 [XT01]	1.3 [XT03]
	Basecoats and sealants	1.6 - 1.8 [96]	1.6 [XT01]	1.8 [XT03]
	Clearcoats	1.4 - 1.6 [96]	1.4 - 1.6 [XT01]	
	Pigmented clearcoats	1.4 [96]	1.4 [XT01]	
GENERAL INDUSTRY	Adhesives			
	Ceramics and abrasives	1.8 CT - 2.8 CT [64S/62S]		1.6 CT - 2.2 CT [3030]
	Paints for Plastic and Sofw	1.4 - 1.8 [96]	1.4 - 1.6 [XT01]	1.4 - 1.6 [XT03]
	Calorific	1.4 - 1.6 [96]	1.4 - 1.6 [XT01]	1.4 [XT03]

INDUSTRY APPLICATION GUIDE

PRESSURE & SUCTION SPRAY GUNS

	MODELS	X 4100 Series Pressure		
		AIRCAPS		
		Transfer / System		
		765/777/62/64/67/20A 55% / Medium Pressure	XT01 B 65% / EPA	XT03 / 3030 75% / HVLP
INDUSTRIAL BODYSHOP	Fillers	1.2 - 1.4 [765]	1.2 - 1.4 [XT01 B]	1.2 - 1.4 [XT03]
	Basecoats	0.8 - 1.0 [777]	0.8 - 1.0 [XT01 B]	0.8 - 1.0 [XT03]
	Clearcoats	1.0 - 1.2 [777]	1.0 - 1.2 [XT01 B]	
	Single stage paints and HS	1.0 - 1.4 [765]	1.2 [XT01 B]	
METAL INDUSTRY	Primers	1.4 - 1.8 [765]	1.4 - 1.6 [XT01 B]	1.4 - 1.6 [XT03]
	Paints and Clears	1.2 - 1.4 [765]	1.2 - 1.4 [XT01 B]	
	Thick coats	2.2 - 2.5 [64]		
	Silicates and abrasives	1.8 CT - 2.8 CT [67/62]		
WOOD INDUSTRY	Dyes	0.8 - 1.0 [765]	0.8 - 1.0 [XT01 B]	0.8 - 1.0 [XT03]
	Basecoats and sealants	1.2 - 1.4 [765]	1.2 - 1.4 [XT01 B]	1.2 - 1.4 [XT03]
	Clearcoats	1.0 - 1.2 [765]	1.0 - 1.2 [XT01 B]	1.2 - 1.4 [XT03]
	Pigmented clearcoats	1.0 - 1.2 [777]	1.0 - 1.2 [XT01 B]	
GENERAL INDUSTRY	Adhesives	1.2 - 1.8 [20A]		
	Ceramics and abrasives	1.4 CT - 2.5 CT [67/64]		1.4 CT - 2.5 CT [3030]
	Paints for Plastic and Sofw	1.0 - 1.2 [777]	1.0 - 1.2 [XT01 B]	
	Calorific	1.0 - 1.4 [765]	1.2 - 1.4 [XT01 B]	1.2 - 1.4 [XT03]

INDUSTRY APPLICATION GUIDE

MIX & AIRLESS SPRAY GUNS



	MODELS	HIGH PRESSURE			
		AIRCAPS			
		System			
		XTREME MIX Mix	MINI XTREME MIX Mix	PSAM 107 Airless	PSAM 104 Airless
WOOD AND METAL INDUSTRY	Varnishes, clearcoats, colours	0,011" - 0,013"	0,011" - 0,013"	0,011"	0,011"
	Undercoats, sealing primers, primers	0,011"	0,011"	0,011" - 0,013"	0,011" - 0,013"
	Waterbased clearcoats and varnishes	0,011" - 0,013"	0,011" - 0,013"	0,011" - 0,013"	0,011" - 0,013"
	Forje effect				
WALL AND CEILING COVERINGS	Plastic paints			0,017" - 0,021"	0,017" - 0,021"
	Multicoloured				
	Waterproof, fireproof			0,021" - 0,026"	0,021" - 0,026"
	Gotele				
	Coarse gotele, Stone pastes, Pastes				

Spray guns application guides



3300 GTO Gravity		
GTO EPA 65% / EPA	GTO HVLP 75% / HVLP	GTO EVO 65% / EPA
1.6 - 1.8 [EPA]	1.6 - 1.8 [HVLP]	
1.4 [EPA]	1.4 [HVLP]	1.3 - 1.4 [EVO]
1.4 - 1.6 [EPA]		1.4 [EVO]
1.6 [EPA]		1.4 [EVO]
1.6 - 1.8 [EPA]	1.8 [HVLP]	
1.6 [EPA]		1.4 [EVO]
2.2 - 2.8 [645/62S]		
1.2 - 1.3 [EPA]	1.2 - 1.3 [HVLP]	
1.8 [EPA]	1.8 [HVLP]	
1.6 [EPA]		1.4 - 1.6 [EVO]
1.4 - 1.6 [EPA]		1.3 - 1.4 [EVO]
2.0 - 2.5 [EPA]		
1.4 - 1.6 [EPA]		1.3 - 1.6 [EVO]
1.4 - 1.6 [EPA]		1.4 [EVO]

Mini Xtreme Gravity	
MINI EPA 65% / EPA	MINI HVLP 75% / HVLP
1.2 - 1.3 [MINI EPA]	1.2 - 1.3 [MINI HVLP]
1.3 - 1.4 [MINI EPA]	
1.3 - 1.4 [MINI EPA]	
1.0 - 1.2 [MINI EPA]	1.2 [MINI HVLP]
1.4 [MINI EPA]	
1.3 [MINI EPA]	
1.3 - 1.4 [MINI EPA]	1.3 - 1.4 [MINI HVLP]
1.3 - 1.4 [MINI EPA]	1.3 - 1.4 [MINI HVLP]

Classic Pro XD Gravity	
21 EPA 65% / EPA	25/28/36 50% / Conventional
1.6 - 1.8 [21 EPA]	
1.6 [21 EPA]	
1.8 [21 EPA]	2.5 [36]
1.6 [21 EPA]	
	2.0 [25] - 2.8 [28]
	2.0 [25] - 2.8 [28]
1.8 [21 EPA]	2.0 [25]
1.4 - 1.8 [21 EPA]	
	2.0 [25] - 2.5 [36]
	2.0 [25] - 2.8 [28]



X 4100 Series Suction	
96 55% / M. Pressure	XT01 65% / EPA
1.8 [96]	1.8 [XT01]
1.4 [96]	1.4 [XT01]
1.6 [96]	1.6 [XT01]
1.8 [96]	1.8 [XT01]
1.6 [96]	1.6 [XT01]
1.4 [96]	1.4 [XT01]
1.6 [96]	1.6 [XT01]
1.6 [96]	1.6 [XT01]
1.4 - 1.6 [96]	1.4 - 1.6 [XT01]

3300 GTO SUCT.
GTO EPA 65% / EPA
1.8 [EPA]
1.4 - 1.6 [EPA]
1.6 [EPA]
1.6 [EPA]
1.8 [EPA]
1.4 - 1.6 [EPA]
1.4 [EPA]
1.8 [EPA]
1.6 - 1.8 [EPA]
1.6 [EPA]
1.6 - 1.8 [EPA]
1.8 [EPA]

Mini Xtreme Pressure	
MINI EPA 65% / EPA	MINI HVLP 75% / HVLP
0.8 - 1.0 [MINI EPA]	0.8 - 1.0 [MINI HVLP]
1.0 - 1.2 [MINI EPA]	1.0 - 1.2 [MINI HVLP]
1.2 [MINI EPA]	
0.8 - 1.0 [MINI EPA]	0.8 - 1.0 [MINI HVLP]
1.0 [MINI EPA]	1.0 [MINI HVLP]
1.0 [MINI EPA]	
1.0 - 1.2 [MINI EPA]	1.0 - 1.2 [MINI HVLP]

3300 GTO Pressure		
765/62/64/67/20 55% / M. Pressure	GTO EPA 65% / EPA	GTO HVLP 75% / HVLP
1.4 [765]	1.4 [EPA]	1.4 [HVLP]
1.6 - 1.8 [765]	1.4 - 1.6 [EPA]	1.4 - 1.6 [HVLP]
1.4 [765]	1.2 - 1.4 [EPA]	
2.2 - 2.5 [64]		
2.5 - 2.8 [67/62]		
	1.4 - 1.6 [EPA]	1.4 - 1.6 [HVLP]
1.4 - 1.6 [765]	1.2 - 1.4 [EPA]	
1.2 - 1.8 [20]		
1.6 - 2.8 [67/62]		





APPLICATION GUIDE
INDUSTRY EQUIPMENT

SYSTEM		Pneumatic Low Pressure Pumps			Pneumatic Mix Pumps			
PUMP MODEL		DM 1/300	DM 1/400	DM 2K	Mack 150 Mix	Mack 320 Mix	Raider 300 Mix	HTV 250
TECHNICAL DETAILS	Air Inlet	max. 7 bar	max. 7 bar	max. 7 bar	max. 7 bar	max. 7 bar	max. 7 bar	max. 7 bar
	Air Consumption	380 L/min.	580 L/min.	580 L/min.	245 L/min.	610 L/min.	370 L/min.	448 L/min.
	Dimensions (mm.)	650 x 600 x 950	650 x 600 x 950	650 x 600 x 950	480 x 470 x 875	480 x 470 x 875	415 x 390 x 745	465 x 460 x 875
	Weight	16 Kg.	18 Kg.	21 Kg.	28 Kg.	30 Kg.	15,5 Kg.	30 Kg.
	Maximum Pressure	6 bar	7 bar	7 bar	91 bar	226 bar	200 bar	175 bar
	Maximum Free Flow	30 L/min.	40 L/min.	40 L/min.	2.7 L/min.	2.7 L/min.	2.7 L/min.	2.54 L/min.
	Maximum tip				0.018"	0.018"	0.013"	0.018"
COMPLEMENTS	SPRAY GUN	X 4100 Series Mini Xtreme Pressure HVLP/EPA V4/V5/V6			Mini Xtreme Mix/403 Mix			Mini Xtreme Mix V7/4041 Mix
	HOSES	Air + Product hose 5 m. 86463818 10 m. 86463819			Air + Product hose 5 m. 86463804 10 m. 86463805			Air + Product mix hose 7 m. 86463869
	PRODUCT NOZZLE/TIP	According to application			Tip mix Standard 814 605 XX			Tip Extra Finish 814 612 XX
App. INDUSTRIAL	Shop Primer	•	•	•				
	Primer averages	•	•	•				
	Thick Coat Primers							
	Zinc Primers	•	•	•				
	Single stage	•	•	•	•	•	•	•
	Enamels	•	•	•	•	•	•	•
	Clearcoats	•	•	•	•	•	•	•
Glues, adhesives	•	•	•					
App. WOOD	Dyes	•	•	•	•	•	•	
	Basecoats	•	•	•	•	•	•	•
	Clears	•	•	•	•	•	•	•
	Pigmented clearcoats	•	•	•	•	•	•	•
	Waterborne clears	•	•	•	•	•	•	•

APPLICATION GUIDE CONSTRUCTION EQUIPMENT

SYSTEM		Electric Airless Pumps			
PUMP MODEL		Atlanta 200 Plus	Atlanta 500	Atlanta 800	Atlanta 800G
TECHNICAL DETAILS	Air Inlet	220V/50Hz	220V/50Hz	220V/50Hz	Gasolina
	Air Consumption	1 HP	2 HP	2.9 HP	5.5 HP
	Dimensions (mm.)	420 x 250 x 630	650 x 400 x 600		
	Weight	27 Kg.	53 Kg.	72 Kg.	
	Maximum Pressure	180 bar	220 bar	220 bar	220 bar
	Maximum Free Flow	2 L/min.	5 L/min.	9 L/min.	8.5 L/min.
	Maximum tip	0.018"	0.026"	0.043"	0.036"
ACCES.	SPRAY GUN	PSAM 104/107			PSAM 107
	HOSES	Airless Dispersions hoses 10 m. 864 638 02 / 20 m. 864 638 03			
	PRODUCT NOZZLE/TIP	Rotating Airless tip			
App. CONSTRUCTION	Undercoats/Primers	•	•	•	•
	Varnishes	•	•		
	Clearcoats	•	•		
	Plastics		•	•	•
	Chlorinated rubber			•	•
	Waterproof		•	•	•
	Fireproof	•	•	•	•
Bituminous			•	•	
Thick epoxy coat			•	•	



Mix Bellow Pumps			Pneumatic Airless Pumps				Electrics Airless Pumps			
HT 10	HT 15	HT 25	Raider 300	Mack 320	Mack 400	Mack 600	Atlanta 200 Plus	Atlanta 500	Atlanta 800	
max. 6 bar			max. 7 bar	max. 7 bar	max. 6 bar		220V/50Hz	220V/50Hz	220V/50Hz	
646 L/min.	800 L/min.	1.326 L/min.	245 L/min.	610 L/min.	1.500 L/min.		1 HP	2 HP	2,9 HP	
575 x 525 x 875			415 x 390 x 745	480 x 470 x 875	545 x 546 x 1.007		420 x 250 x 630	650 x 400 x 600		
41 Kg.	42 Kg.	48 Kg.	15,5 Kg.	30 Kg.	62 Kg.	63 Kg.	27 Kg.	53 Kg.	72 Kg.	
60 bar	90 bar	150 bar	200 bar	226 bar	240 bar	360 bar	180 bar	220 bar	220 bar	
9.75 L/min.			2.7 L/min.	2.7 L/min.	7.2 L/min.	5.2 L/min.	2 L/min.	5 L/min.	9 L/min.	
0.018"			0.013"	0.018"	0.032"		0.018"	0.026"	0.043"	
Mini Xtreme Mix V7/4041 Mix			PSAM 104/107/110							
Air + Product mix hose 10 m. 86463805			Standard airless hose 10 m. 86463804 15 m. 86463805				Airless dispersions hose 10 m. 86463802	Airless dispersions hose 10 m. 86463802 15 m. 86463803		
Tip Extra Finish 814 612 XX			Tip Airless swivelling 814 611 XX Rotating head 81461101				Tip Airless swivelling 814 611 XX Rotating head 81461101			
			•	•	•				•	
				•	•		•	•	•	
									•	
	•	•	•	•	•	•	•	•	•	
•	•	•	•	•	•	•	•	•	•	
•	•	•	•	•	•	•	•	•	•	
•	•	•	•	•	•	•	•	•	•	
•	•	•	•	•	•	•	•	•	•	
•	•	•	•	•	•	•	•	•	•	
•	•	•	•	•	•	•	•	•	•	
•	•	•	•	•	•	•	•	•	•	





SAGOLA SA
Urartea, 6 · 01010
Vitoria-Gasteiz (Álava) SPAIN
Tel.: (+34) 945 214 150
sagola@sagola.com
www.sagola.com

