

ARO®

PISTON PUMPS

ACCESSORIES



About ARO®



ARO® is a worldwide manufacturer of fluid management products that are skillfully engineered to deliver performance and serviceability, allowing success to flow freely in our customers' businesses. That's why ARO® is fluid intelligence—the smart choice in fluid management products for industrial operations.

With over an 85-year legacy of premier product performance and service excellence, ARO® provides fluid management equipment for customers and industries around the globe, including chemical, manufacturing, energy, pharmaceutical, mining and more.

ARO® has the right product to meet our customers' specific needs. We offer air-operated diaphragm pumps, piston pumps and packages, filters, regulators, and lubricators (FRLs), lubrication equipment, and pneumatic valves and cylinders.

Piston Pump Family Port Sizes

Pump Family	Pump Type	Ratio	Air or Hyd. Inlet Size (F)	Mat. Out. Size (F)	Pump Family	Pump Type	Ratio	Air or Hyd. Inlet Size (F)	Mat. Out. Size (F)	Pump Family	Pump Type	Ratio	Air or Hyd. Inlet Size (F)	Mat. Out. Size (F)
650311-X	2-Ball	2:1	1/4 (6.3)	3/4 (19.0)	NM2304X-XX-B	2-Ball	4:1	1/4 (6.3)	3/4 (19.0)	AF1230511XXXX	Chop-Check	30:1	3/4 (19.0)	1½ (38.1)
650312-X	2-Ball	2:1	1/4 (6.3)	3/4 (19.0)	NM2318B-XX-B	2-Ball	18:1	1/4 (6.3)	1/4 (6.3)	AF1265511XXXX	Chop-Check	65:1	3/4 (19.0)	1¼ (31.7)
650313-X	2-Ball	4:1	1/4 (6.3)	3/4 (19.0)	NM2328A-11-X11	2-Ball	28:1	1/4 (6.3)	1/4 (6.3)	NM2322X-X1-B	Chop-Check	22:1	1/4 (6.3)	1/2 (12.7)
650314-X	2-Ball	4:1	1/4 (6.3)	3/4 (19.0)	AF0402M11XXXX	4-Ball	2:1	1/2 (12.7)	1(25.4)	650940-XXD-B	Hyd 2-Ball	.8:1	1/2 (12.7)	1¼ (31.7)
AF0409AX1XX24-02	2-Ball	9:1	1/2 (12.7)	3/4 (19.0)	AF0603M11XXXX	4-Ball	3:1	1/2 (12.7)	1(25.4)	650943-XXX-B	Hyd 2-Ball	1.7:1	3/8 (9.5)	1(25.4)
AF0409CXXXXXX	2-Ball	9:1	1/2 (12.7)	3/4 (19.0)	AF0604M11XXXX	4-Ball	4:1	1/2 (12.7)	1(25.4)	650944-XXX-B	Hyd 2-Ball	3.3:1	3/8 (9.5)	1(25.4)
AF0411G11XXXX	2-Ball	11:1	1/2 (12.7)	1(25.4)	AF0805M11XXXX	4-Ball	5:1	3/4 (19.0)	1(25.4)	650949-X4X	Hyd 4-Ball	3.3:1	3/8 (9.5)	1(25.4)
AF0422G11XXXX	2-Ball	22:1	1/2 (12.7)	1(25.4)	AF0807M11XXXX	4-Ball	7:1	3/4 (19.0)	1(25.4)	650950-X4X	Hyd 4-Ball	.2:1	3/8 (9.5)	1(25.4)
AF0430G11XXXX	2-Ball	30:1	1/2 (12.7)	1(25.4)	650934-X43-C	Chop-Check	2:1	3/8 (9.5)	1(25.4)	650941-XXE-C	Hyd Chop-Check	1.2:1	1/2 (12.7)	1½ (38.1)
AF0623G11XXXX	2-Ball	23:1	1/2 (12.7)	1(25.4)	650935-X43-C	Chop-Check	3.6:1	3/8 (9.5)	1(25.4)	AF0450LXXXXXX	Lube - Grease	50:1	1/2 (12.7)	1/2 (12.7)
AF0645G11XXXX	2-Ball	45:1	1/2 (12.7)	1(25.4)	AF0412S11XXXX	Chop-Check	12:1	1/2 (12.7)	1(25.4)	AF0475LXXXXXX	Lube - Grease	75:1	1/2 (12.7)	1/2 (12.7)
AF0660G11XXXX	2-Ball	60:1	1/2 (12.7)	1(25.4)	AF0423S11XXXX	Chop-Check	23:1	1/2 (12.7)	1(25.4)	AF0608LXXXXXX	Lube - Grease	100:1	1/2 (12.7)	1/2 (12.7)
AF0810X11XXXX	2-Ball	10:1	3/4 (19.0)	1¼ (31.7)	AF0443X21XXXX	Chop-Check	43:1	1/2 (12.7)	1/2 (12.7)	LM2250E-XX-B	Lube - Grease	50:1	1/4 (6.3)	3/8 (9.5)
AF0828B11XXXX	2-Ball	28:1	3/4 (19.0)	1(25.4)	AF0623S11XXXX	Chop-Check	23:1	1/2 (12.7)	1(25.4)	LM2350E-XX-B	Lube - Grease	50:01:00	1/4 (6.3)	3/8 (9.5)
AF0840G11XXXX	2-Ball	40:1	3/4 (19.0)	1(25.4)	AF0646S11XXXX	Chop-Check	46:1	1/2 (12.7)	1(25.4)	61204X-X	Lube - Oil	1:1	1/4 (6.3)	3/4 (19.0)
AF1015XXXXXX	2-Ball	15:1	3/4 (19.0)	1¼ (31.7)	AF0665S11XXXX	Chop-Check	65:1	1/2 (12.7)	3/4 (19.0)	65011X-X	Lube - Oil	2:1	1/4 (6.3)	1/2 (12.7)
AF1045B11XXXX	2-Ball	45:1	3/4 (19.0)	1(25.4)	AF0813S11XXXX	Chop-Check	13:1	3/4 (19.0)	1½ (38.1)	AF0409AX3XXXXXX	Lube - Oil	9:1	1/2 (12.7)	3/4 (19.0)
AF1223X1XXXX	2-Ball	23:1	3/4 (19.0)	1¼ (31.7)	AF0828S11XXXX	Chop-Check	28:1	3/4 (19.0)	1¼ (31.7)	LM2203A-XX-C	Lube - Oil	3:1	1/4 (6.3)	1/2 (12.7)
AF1223X5XXXX	2-Ball	23:1	3/4 (19.0)	1¼ (31.7)	AF0844S11XXXX	Chop-Check	44:1	3/4 (19.0)	1(25.4)	LM2305A-XX-B	Lube - Oil	5:1	1/4 (6.3)	1/2 (12.7)
AF1265B11XXXX	2-Ball	65:1	3/4 (19.0)	1(25.4)	AF1020S11XXXX	Chop-Check	20:1	3/4 (19.0)	1½ (38.1)					
NM2202X-XX-B	2-Ball	2:1	1/4 (6.3)	3/4 (19.0)	AF1044S11XXXX	Chop-Check	44:1	3/4 (19.0)	1¼ (31.7)					

Table of Contents

<ul style="list-style-type: none"> <ul style="list-style-type: none"> - Portable and Stationary 	4	<ul style="list-style-type: none"> Gauges 	18
<ul style="list-style-type: none"> - Floor, Wall and Mounting Post 	5	<ul style="list-style-type: none"> Guns - Extrusion and Tips - Airless and Tips 	19 20
<ul style="list-style-type: none"> - Single and 2-Post 	6	<ul style="list-style-type: none"> Control Handles - Non-Metered, Metered and Nozzles - Grease 	22 24
<ul style="list-style-type: none"> - 5-Gallon Containers - 55-Gallon Containers - Lubrication - Accessories: Seal Protectors, Adapters, Gaskets, Drum Stops, Low Level Cutoff Kits, Drum Hold Down Kits, Crossover Kits 	7 9 10 11 12	<ul style="list-style-type: none"> Heaters Valves Filters Hoses - Fluid Hoses - Siphon Hoses 	24 25 27 28 30
<ul style="list-style-type: none"> - Industrial and Lubrication 	13	<ul style="list-style-type: none"> Overrun Controls Agitators Adapters / Pressure Relief Valves Mufflers / Ball Valve Regulators / Swivels Fittings / Flow Control Valves Filters / Regulators / Lubricators 	31 32 33 34 35 38
<ul style="list-style-type: none"> - Industrial and Lubrication 	14		
	14		
	15		

Common Industrial Installation

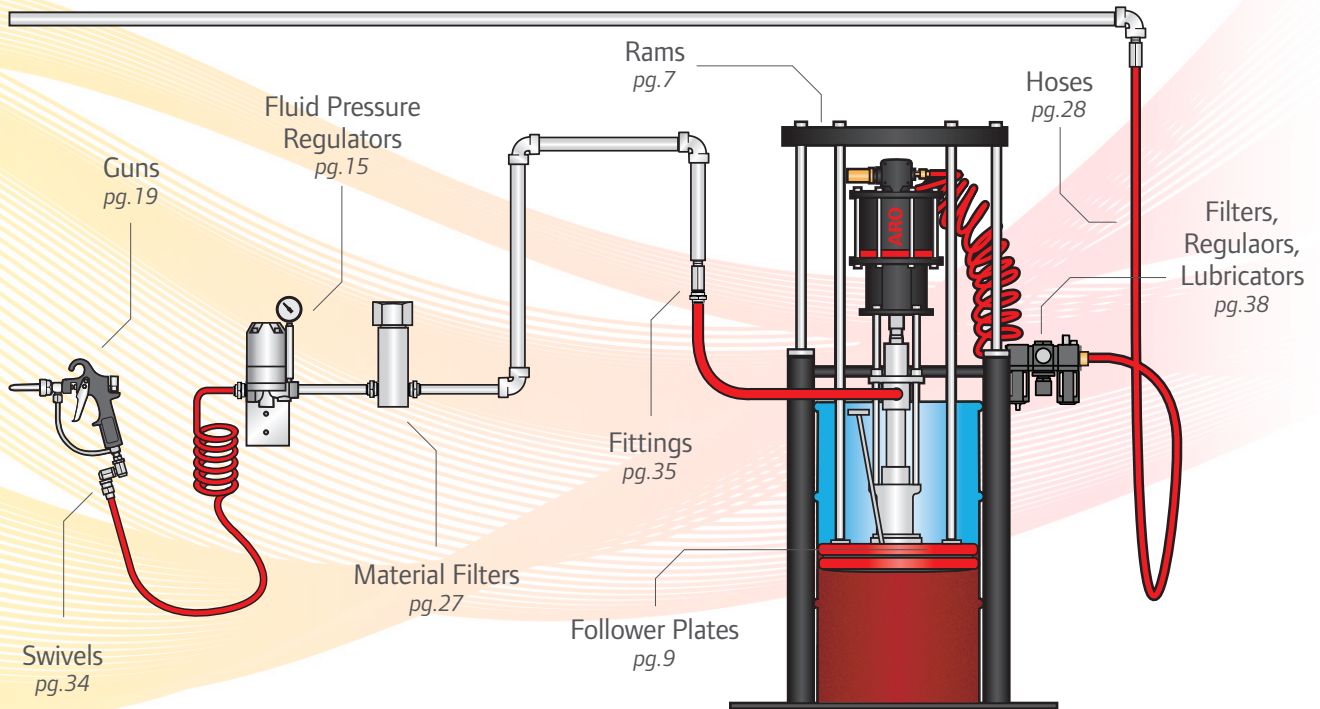

Portable - Single Post Lifts

Model	Description	Dimensions	Use With
SINGLE-POST			
67075-B	For use with 5-gallon pails containing fluids with viscosities up to 200,000 cPs. A needle valve allows the operator to control the speed at which the pump is raised and lowered.	Base: 26.593" (675.5 mm) x 27.5" 698.5 mm)	CL0443X2XXXXXXXXXX and NP322L0X0X
67075-1-B		Height: 42.921" (1090.2 mm) lowered	CL0409A9XXXXXXXXXX
67425-1	For use with 5-gallon pails containing fluids with viscosities up to 200,000 cPs. A needle valve allows the operator to control the speed at which the pump is raised and lowered.	Base: 21.844" (554.8mm) x 27-1/2" (698.5mm) Height: 41.947" (1065.4mm) lowered	Packages that include the RM051X-X-B Single Post 5 gallon ram



67075-B



640067

Stationary - Single Post Lift

Model	Description	Dimensions	Use With
SINGLE-POST			
640067	For use with 55-gallon drums. Lift is bolted to floor. Support arms attach to drum cover. Lift is used to raise drum cover and bung-mounted pump. Use when pumping grease, oil and low-viscosity fluids.	Height (lowered): 55-1/2" (1409.7 mm) Height (raised): 92" (2336.8 mm)	<ul style="list-style-type: none"> All 55-gallon bung-type pumps 651852 or 66197 drum covers



66554-2

Portable - Carts

Model	Description	Use With
66554-2	• 24" to 30" wheel spacing adjustment; has 16" tires	<ul style="list-style-type: none"> 8", 10" and 12" air motor 2-ball pumps 8" air motor Integrity 2-ball pumps
67139	<ul style="list-style-type: none"> Will clear 28" openings Unique chair design distributes pump weight and makes moving easy 12" (305 mm) pneumatic tires also enhance smooth transport 	<ul style="list-style-type: none"> 4-1/4" and 6" Integrity 2-ball pumps



67139

Wall Mounts

Model	Description	Use With
61113	<ul style="list-style-type: none"> 2" NPT(F) opening to accept bung type pumps Bracket slips over rim of open head drum or can be wall-mounted 	<ul style="list-style-type: none"> 612041-X, NM2202A-41-X, NM2202B-41-X, NM2304A-41-X, NM2304B-41-X, 650409-X and 650453-X
66100	<ul style="list-style-type: none"> With 91395 removable mounting plate 	<ul style="list-style-type: none"> 4-1/4" air motor 4" stroke pumps
66101	<ul style="list-style-type: none"> With 91396 removable mounting plate 	<ul style="list-style-type: none"> 4-1/4" and 6" air motor 2-ball and 4-ball pumps; including Integrity and Stinger models
66542	<ul style="list-style-type: none"> With 92371 removable mounting plate 	<ul style="list-style-type: none"> 8", 10" and 12" air motor 2-ball pumps 8" air motor Stinger 4-ball pumps
76763	<ul style="list-style-type: none"> Open front permits easy installation of pump Can be bolted to wall at back or side of bracket 	<ul style="list-style-type: none"> All "N" Series and 1/2" diaphragm pumps



61113

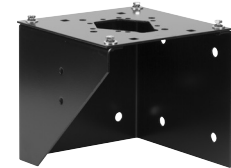

66100



76763

Stationary - Mounting Post

Model	Description	Use With
67187-1	<ul style="list-style-type: none"> Floor stand pump mounting post 	<ul style="list-style-type: none"> 4-1/4", 6" and 8" air motors, except AF0828BXXXXXXXX-X and AF0810XXXXXXXX-X



67187-1

Floor Mounts

Model	Description	Use With
65138	<ul style="list-style-type: none"> Accepts fluid line from bulk containers or mixing tanks 3" NPT(F) inlet; 1/4" NPT(F) vent port with plug 	<ul style="list-style-type: none"> 4-1/4" and 6" air motor, 2-ball and extrusion pumps 8" 40:1 2-ball and 44:1 extrusion pumps Hydraulic: 0.8:1 and 3.3:1 2-ball; 2:1 and 3.6:1 chop-check pumps Mounting footprint "A"
65139	<ul style="list-style-type: none"> Accepts fluid line from bulk containers or mixing tanks 3" NPT(F) inlet; 1/4" NPT(F) vent port with plug 	<ul style="list-style-type: none"> 8", 10", or 12" air motor, 2-ball and extrusion pumps Hydraulic: 1.2:1 chop-check; 2.4:1 2-ball pumps Mounting footprint "B"



65139

Dollies

Hand
Trucks

16-Gallon Drum

Dollies

Model	Description
16-GALLON	
640057	Platform-type dolly has four swivel casters and three drum clamps; for use with steel or fiber drums
640058-2	Band-type dolly has four rubber-wheeled casters and screw clamp; for use with steel or fiber drums



640057



640058-2

Hand Trucks

Model	Description
16-GALLON	
640062	Two-wheel truck has clamp rod and two base supports to hold drum; wheels are rubber
640149	Three-wheel truck includes hinged handle, swivel-type front wheel, and two 6" (152 mm) rubber rear wheels



640062



640149

Rams

Single Post, for 5 gallon containers Two-Post, for 5 and 55 gallon containers

(RAMS ONLY, FOLLOWER PLATES NOT INCLUDED)

Single post or two post mounts for lifting/lowering pump with follower plate into/out of 5-gallon or 55 gallon containers.

Integrated control options for ram only or ram and pump. Controls include pump air filter/regulator with gauge, pump lock-out valve, lift and ram air regulator with gauge, air supply for follower plate.



RM051S-C-B



RM052S-C



RM552S-C

Model	Container Suitability (gal)	Posts	Basic Controls (ram only)	Advanced Controls (pump & ram)	Heavy Duty Cylinders	Base Dimensions	Height Lowered - Raised
RM051S-B-B	5	1	x			15" x 19" (381 mm x 482.6 mm)	42.759" (1086.1mm) - 67.759 (1721.0 mm)
RM051S-C-B	5	1		x			
RM052S-B	5	2	x			19.75" (501.65mm) x 24.00" (609.6mm)	35.61" (904.5mm) - 53.404" (1356.4 mm)
RM052S-C	5	2		x			
RM552S-B	55	2	x			24.00" (609.6 mm) x 42.782" (1086.7 mm)	61.465" (11561.2mm) - 99.215" (2520.1mm)
RM552S-C	55	2		x			
RM552H-B	55	2	x		x		
RM552H-C	55	2		x	x		

See follower plate pages for ram and follower plate packages overview.

Mounting Configuration

Follower plates seal the container and direct fluid toward the pump inlet. Pumps mount directly to the follower plate, which are sized for 5-gallon or 55-gallon containers. Follower plates with single-lip seals are designed for fluid viscosities up to 300,000 cPs. Use double-lip seals for viscosities over 300,000 cPs. Tube-type seals are also available for applications using 55-gallon drums.

Mounting Configurations

Mounting footprint is strictly a reference letter used to simplify the matching of pumps to follower plates and related accessories (i.e., a pump with an "A" mounting footprint will fit any accessory with an "A" mounting footprint).



Footprint A

Footprint used on 5-gallon follower plates, 55-gallon follower plates and 65138 mounting pedestal.

- Footprint matches the bolt configuration of flange inlet of chop-check lower ends.
- Footprint matches 67136 plate adapter for 2-ball pumps.



Footprint B

Footprint used on 55-gallon follower plates and mounting 67139 pedestal.

- Footprint matches the bolt configuration of flange inlet of chop-check lower ends.
- Footprint matches inlet for some large displacement 2-ball pumps.



Footprint C and D

Footprint fits 5-gallon pails, used with lifts and single-post rams.

- "C" designates slip-on connection to lower end.
- "D" designates 2" NPTF threads for use with Integrity style 2-ball lower ends.

Types of Follower Plates

ARO® offers several types of follower plates for use with 5-gallon pails and 55-gallon drums. Standard, or flat, follower plates are used where fluid viscosities reach 500,000 to 750,000 cPs. High-viscosity, or tapered, follower plates are used where fluid viscosities that exceed 750,000 cPs.



Flat, Single-Lip Follower Plates

For 5-gallon pails and 55-gallon drums



Flat, Double-Lip Follower Plates

For 5-gallon pails and 55-gallon drums



Tapered, Tube-Type Follower Plates

For 55-gallon drums

5-Gallon Containers

Mounting footprint is strictly a reference letter used to simplify the matching of pumps to follower plates and related accessories. For example, a pump with an "A" mounting footprint will fit any accessory with an "A" mounting footprint.

Follower ASM	Pump Size	Follower Plate Material	Seal Type	Seal Material	Seal Diameter	Used With	Ram Model # Coding	Modular Design*	
67347-2	Standard Footprint "A"	Aluminum	Single Tube	EPR	11.440" (290.6 mm)	RM051S-XXX-XX-B (Single Post) RM052S-XXX-X (Two Post)"	RM05XS-XXA-A7-B		
67347-1				Nitrile			RM05XS-XXA-A8-B		
67347-12				Aluminum with PTFE Coating			EPR	RM05XS-XXA-T7-B	
67347-11							Nitrile	RM05XS-XXA-T8-B	
67485-2		Carbon Steel, Electroless Nickel Coating	Single Lip	Nitrile / Polyethylene	11.614" (295.0 mm)		RM05XS-XXA-E1-B	Y	
67485-1				Polyurethane / Polyethylene	11.437" (290.5 mm)		RM05XS-XXA-E3-B	Y	
67485-3				Nitrile / Polyethylene	12.281" (311.9 mm)		RM05XS-XXA-E5-B	Y	
66732-1			Double Lip	Polyurethane	11.609" (294.9 mm)		RM05XS-XXA-EA-B		
66732-2				EPR			RM05XS-XXA-EB-B		
66732				Nitrile			RM05XS-XXA-EC-B		
67486-2		Slip-On "C"	Carbon Steel, Electroless Nickel Coating	Single Lip	Nitrile / Polyethylene		11.614" (295.0 mm)	RM05XS-XXC-E1-B	Y
67486-1					Polyurethane / Polyethylene		11.437" (290.5 mm)	RM05XS-XXC-E3-B	Y
67486-3	Nitrile / Polyethylene				12.281" (311.9 mm)	RM05XS-XXC-E5-B	Y		
66731-1	Double Lip				Polyurethane	11.609" (294.9 mm)	RM05XS-XXC-EA-B		
66731-2			EPR	RM05XS-XXC-EB-B					
66731			Nitrile	RM05XS-XXC-EC-B					
67487-1			Stainless Steel	Single Lip	PTFE Coated Nitrile / Polyethylene		11.437" (290.5 mm)	RM05XS-XXC-S2-B	Y
67518-1	PTFE Coated Nitrile / Polyethylene				RM05XS-XXD-S2-B	Y			

*Modular design: backup ring can be manipulated or removed to fit various 5 gallon pail diameters and types (tapered, straight)



55-Gallon Containers

Follower ASM	Pump Size	Follower Type	Follower Plate Material	Seal Type	Seal Material	Used With	Ram Model # Coding	
66516-1	Standard Footprint	Flat	Aluminum	Double Up	Polyurethane	RM552H-XXX-XX (Two Post, Heavy Duty) RM552S-XXX-XX (Two Post, Standard)	RM552X-XXX- AA	
66516-2					EPR		RM552X-XXX- AB	
66516					Nitrile		RM552X-XXX- AC	
67195-1					Neoprene		RM552X-XXX- AM	
67195-2		EPR		RM552X-XXX- AN				
67195-8		Neoprene, Reduced OD		RM552X-XXX- AS				
67195-3		Viton		RM552X-XXX- AV				
67516-1		Neoprene		RM552X-XXX- AE				
67516-2		EPR	RM552X-XXX- AF					
67516-8		Neoprene, Reduced OD	RM552X-XXX- AH					
67516-3		Viton	RM552X-XXX- AJ					
66516-6		Flat	Double Up	Aluminum with PTFE Coating	Polyurethane		RM552X-XXX- TA	
66516-7					EPR		RM552X-XXX- TB	
66516-5					Nitrile		RM552X-XXX- TC	
67195-5					Neoprene		RM552X-XXX- TM	
67195-6			EPR		RM552X-XXX- TN			
67195-9			Neoprene, Reduced OD		RM552X-XXX- TS			
67195-7			Viton		RM552X-XXX- TV			
67516-5			Neoprene		RM552X-XXX- TE			
67516-6			EPR	RM552X-XXX- TF				
67516-9			Neoprene, Reduced OD	RM552X-XXX- TH				
67516-7			Viton	RM552X-XXX- TJ				
66517-1			Large Footprint	Flat	Aluminum		Double Up	Polyurethane
66517-2		EPR						RM552X-XXB- AB
66517		Nitrile						RM552X-XXB- AC
67196-1		Neoprene						RM552X-XXB- AM
67196-2		EPR		RM552X-XXB- AN				
67196-8		Neoprene, Reduced OD		RM552X-XXB- AS				
67196-3	Viton	RM552X-XXB- AV						
67515-1	Neoprene	RM552X-XXB- AE						
67515-2	EPR	RM552X-XXB- AF						
67515-8	Neoprene, Reduced OD	RM552X-XXB- AH						
67515-3	Viton	RM552X-XXB- AJ						

55-Gallon Containers (continued from page 9)

Follower ASM	Pump Size	Follower Type	Follower Plate Material	Seal Type	Seal Material	Used With	Ram Model # Coding		
66517-6	Large Footprint	Flat	Aluminum with PTFE Coating	Double Lip	Polyurethane	RM552H-XXX-XX (Two Post, Heavy Duty)	RM552X-XXB- TA		
66517-7					EPR		RM552X-XXB- TB		
66517-5					Nitrile		RM552X-XXB- TC		
67196-5		Tapered		Double Tube	Neoprene		RM552X-XXB- TM		
67196-6					EPR		RM552X-XXB- TN		
67196-9					Neoprene, Reduced OD		RM552X-XXB- TS		
67196-7					Viton		RM552X-XXB- TV		
67515-5					Flat		Double Tube	Neoprene	RM552X-XXB- TE
67515-6								EPR	RM552X-XXB- TF
67515-9		Neoprene, Reduced OD		RM552X-XXB- TH					
67515-7		Viton		RM552X-XXB- TJ					
67409-1		Large Footprint with ball valve		Flat				Aluminum	Double Lip
67409-2	EPR		RM552X-XXE- AB						
67409	Nitrile		RM552X-XXE- AC						
67410-1	Tapered		Double Tube	Neoprene	RM552X-XXE- AM				
67410-2				EPR	RM552X-XXE- AN				
67410-8				Neoprene, Reduced OD	RM552X-XXE- AS				
67410-3				Viton	RM552X-XXE- AV				
67409-6				Flat	Double Lip	Polyurethane	RM552X-XXE- TA		
67409-7						EPR	RM552X-XXE- TB		
67409-5	Nitrile		RM552X-XXE- TC						
67410-5	Neoprene		RM552X-XXE- TM						
67410-6	EPR		RM552X-XXE- TN						
67410-9	Neoprene, Reduced OD		RM552X-XXE- TS						
67410-7	Viton		RM552X-XXE- TV						

Lubrication

Follower Plates

Model	Wiper seal material	OD of pump tube to be fitted in (mm)	For use with
35-LB TAPERED PAIL (FITS 10" – 11" ID DRUMS)			
640095-1-B	Rubber	1" (25)	Thunder Series 60:1
640095-2-B	Rubber	1-1/2" (38)	LM2250E-21-B, LM2350E-21-B
120-LB DRUM (FITS 13" – 14" ID DRUMS)			
640027	Buna-N	2" (51)	Hand pumps
640152	Buna-N	1-7/8" (48)	425 Series, 50:1
640152-1	Buna-N	2-1/8" (54)	600 Series, 100:1
640165	Buna-N	1-1/2" (38)	LM2250E-31-B, LM2350E-31-B
400-LB DRUM (FITS 20" – 23" ID DRUMS)			
640015-2	Buna-N	1-7/8" (48)	425 Series, 50:1
640015-5	Buna-N	2-1/8" (54)	600 Series, 100:1
640015-1	Buna-N	1-1/2" (38)	LM2250E-41-B, LM2350E-41-B

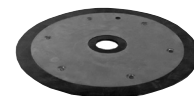

640095-2-B

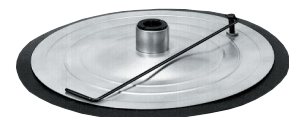

640015-1

Follower Plate Accessories

Part Number	Description
91363-10	SEAL PROTECTORS
Features:	<ul style="list-style-type: none"> • Seals fit between follower plate and material to prevent corrosive fluids from attacking the follower plate wiper • Reduces clean-up time, sold in packages of 10 • Made of low-density polyethylene, 0.010" – 0.015" thick
Used With:	• 55-gallon follower plates
67136	FOLLOWER PLATE ADAPTER
Features:	<ul style="list-style-type: none"> • For attaching Integrity 2-ball pumps to follower plates or 67138 floor mount; includes stainless steel adapter with 2" NPT (F) threads, seal, and hardware • Mounting footprint A
Used With:	<ul style="list-style-type: none"> • 651616-1,-2,-3 two-post rams • 66248 and 66516 follower plates • 65138 floor mount
67134	FOLLOWER PLATE ADAPTER
Features:	• For attaching NM2322X- (22:1) and 6712X-X (43:1) ratio models
Used With:	<ul style="list-style-type: none"> • 55-gallon follower plates and 67138 floor mount • Mounting footprint A
90552	GASKET
Features:	• Fits between follower plate and inlet of pump
Used With:	<ul style="list-style-type: none"> • 67136 follower plate adapter • Chop-check pumps that have footprint A style flange inlets
92339	GASKET
Features:	• Fits between follower plate and inlet of pump
Used With:	• Chop-check pumps that have footprint B style flange inlets
67517	DRUM STOPS
Features:	• Attaches to ram base plate to ensure proper drum placement
Used With:	• RM552X-X
LOW LEVEL CUTOFF KITS	
Features:	• Kits are mounted on ram, prevent pump from running dry by shutting off air supply when material level is low.
67500	Used With: RM052S-XXX-XX
67501	Used With: RM552S-XXX-XX / RM552H-XXX-XX
67502	Used With: RM051S-XXX-XX-B
DRUM HOLD DOWN KIT	
Features:	• Keeps drum from lifting when removing pump/follower
67503	Used With: RM552S-X
67504	Used With: RM552H-X
CROSSOVER KITS	
Features:	• Shifts pump operation from one pump and ram package to another, to keep process moving without interruption while material containers are changed
67448	Used With: RM052X-X, RM552X-X
67449	Used With: RM051X-X



67136



67500

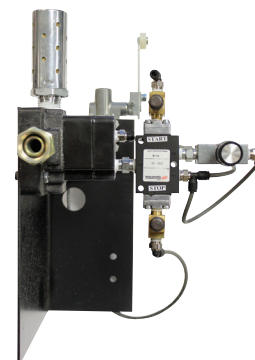

67448

Industrial Drum Covers

Part Number	Description
66971	DRUM COVER
Features	• Stainless steel, accepts 651100 agitator
Used With	• 1/2" ports diaphragm pump
Container Size	• 5 gallon
66197	DRUM COVER
Features	• Includes hinged access covers, 2" NPT(F) bung opening, and will accept 651104-1 agitator • Carbon steel
Used With	• 2", 3" and 4-1/4" 55-gal bung-type pumps
Container Size	• 55 gallon
651852	DRUM COVER AND AGITATOR PACKAGE
Features	• Includes hinged access covers, 2" NPT(F) bung opening, 2" x 34" pipe extension and 60307-1 agitator • Carbon steel
Used With	• Accepts 65986-1 siphon hose from any wall-mounted pump; any 55-gallon bung-type pump that can be used with 640067 lift
Container Size	• 55 gallon



66971



651852

Lubrication Drum Covers

Model	Description	For use with
5 GAL / 35-LB PAIL		
94420	Has 2" (50.8 mm) NPT (F) bung opening and three hold-down screws (fits 10.23" – 12", 259.8 mm – 304.8 mm OD drums)	Thunder Series 5-gal (18.9 L) bung pumps
16 GAL / 120-LB DRUM		
66492	Has pump opening, mounting holes, and tie-down brackets; order tie-down rods separately (fits 12.75" – 15", 323.8 mm – 381 mm OD Drums)	Models 662402 and 662409
94421	Has 2" (50.8 mm) NPT (F) bung opening and three hold-down screws (fits 13-1/8" – 14-7/8", 333.3 mm – 377.8 mm OD drums)	Thunder Series 16-gal / 120 lb (60.6 L / 54.4 kg) bung pumps
55 GAL / 400-LB DRUM		
71060-1	Has 2" (50.8 mm) NPT (F) bung opening and tie-down brackets; order tie-down rods separately (fits 20" – 24-5/8", 508 mm – 625.5 mm OD drums)	200 Series and 425 Series, 55-gal / 400-lb (208.1 L / 181.4 kg) bung-type
94422	Has 2" (50.8 m) NPT (F) bung opening and three hold-down screws; bung pumps (fits 21-7/8" – 23-5/8", 555.6 mm – 600.1 mm OD drums)	55-gal (208.1 L) drum cover models LM2250E-41-B and LM2350E-41-B



94420



94421



71060-1



94422

**Tie-Down
Rods**

Tie-Down Rods

Cover Tie-down Rods

Model	Description	For use with
16-GAL / 120-LB DRUM		
640164	Tie-down bracket kit fixes / holds down drum cover. Includes brackets, rods, mounting hardware. Use with 94421 Cover.	Thunder Series pumps.
640091	Set of two tie-down rods and mounting brackets. Use with 66492 Cover.	Series 200 and 425, 16-gal / 120-lb (60.6 L / 54.4 kg) drum covers
55-GAL / 400-LB DRUM		
71027-1	Set of two tie-down rods and mounting brackets. Use with 71060 cover.	Thunder Series, also 200 and 425 Series, 55-gal / 400-lb (208.1 L / 181.4 kg) drum covers



**Bung
Adapters**

Adapters and Kits

Bung Adapters

Model	Description	For use with
60870	2" (50.8 mm) (M) for use with 2-1/8" (57.1 mm) siphon tube	200 Series, 1:1 ratio immersed pumps 425 Series, 9:1 ratio immersed pumps
67145-3-B	2" (50.8 mm) (M)	Thunder Series, 3:1 oil pumps
67145-4-B	2" (50.8 mm) (M)	Thunder Series, 5:1 oil pumps
4148	2" (50.8 mm) (M) for use with 1-7/8" (47.6 mm) siphon tube	425 Series, 50:1 ratio grease pumps
67145-2	2" (50.8 mm) (M)	Thunder Series, 50:1 grease pumps
BUNG ADAPTER SEAL KITS		
67088-3	Water-tight seal kit includes 67145-3 bung adapter and 67088 seal kit	Thunder Series 3:1 oil pumps
67088-4	Same as above, except includes 67145-4 bung adapter and 67088 seal kit	Thunder Series 5:1 oil pumps
67088	Water-tight seal for use outdoors	Thunder Series



67145-X

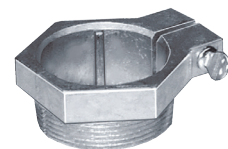

67145-3-B

Fluid Pressure Regulators

Ingersoll Rand / ARO® I.D.L.® (Improved Design Line) Fluid Regulators feature smooth, consistent pressure regulation with easy-turn adjustment. Patented easy-access seat plug permits immediate service access to the regulator's ball and seat. Patented "floating" ball and seat design maintains proper regulation, even during significant fluctuations in line pressure.



3/8" Ports
(651780-A1A-B)



3/4" Ports
(651780-C1C-B)



3/8" Ports,
Remote Regulator
(651780-B1R-B)

Downstream Regulators - High Pressure

Model	Regulated Pressure Range psi (bar)	Maximum Inlet Pressure psi (bar)	Port Size	Housing Base	Seat	Gauge
651780-A1A-B	400 – 1,250 (27.6 – 86.2)	3,000 (206.9)	3/8"	Carbon steel	Tungsten carbide	No
651780-A1B-B	1,000 – 3,000 (69.0 – 206.9)	6,000 (413.8)	3/8"	Carbon steel	Tungsten carbide	No
651780-A3A-B	400 – 1,250 (27.6 – 86.2)	3,000 (206.9)	3/8"	300 Series stainless	Tungsten carbide	No
651780-A3B-B	1,000 – 3,000 (69.0 – 206.9)	6,000 (413.8)	3/8"	300 Series stainless	Tungsten carbide	No
651780-B1A-B	400 – 1,250 (27.6 – 86.2)	3,000 (206.9)	3/8"	Carbon steel	Tungsten carbide	No
651780-B1B-B	1,000 – 3,000 (69 – 206.9)	6,000 (413.8)	3/8"	Carbon steel	Tungsten carbide	No
651780-B1R-B	400 – 5,000 (27.6 – 344.8)	6,000 (413.8)	3/8"	Carbon steel	Tungsten carbide	No
651780-B3A-B	400 – 1,250 (27.6 – 86.2)	3,000 (206.9)	3/8"	300 Series stainless	Tungsten carbide	No
651780-B3B-B	1,000 – 3,000 (69 – 206.9)	6,000 (413.8)	3/8"	300 Series stainless	Tungsten carbide	No
651780-B3R-B	400 – 5,000 (27.6 – 344.8)	6,000 (413.8)	3/8"	300 Series stainless	Tungsten carbide	No
651780-C1B-B	750 – 2,500 (51.7 – 172.4)	6,000 (413.8)	3/4"	Carbon steel	Tungsten carbide	No
651780-C1C-B	2,000 – 5,000 (137.9 – 344.8)	6,000 (413.8)	3/4"	Carbon steel	Tungsten carbide	No
651780-C1R-B	750 – 5,000 (51.7 – 344.8)	6,000 (413.8)	3/4"	Carbon steel	Tungsten carbide	No
651780-C3B-B	750 – 2,500 (51.7 – 172.4)	6,000 (413.8)	3/4"	300 Series stainless	Tungsten carbide	No
651780-C3R-B	750 – 5,000 (51.7 – 344.8)	6,000 (413.8)	3/4"	300 Series stainless	Tungsten carbide	No

Downstream Regulators - Low Pressure

Model	Regulated Pressure Range psi (bar)	Maximum Inlet Pressure psi (bar)	Port Size	Housing Base	Seat	Gauge	Pressure Range psi (bar)
651790-A1B-B	5 – 30 (0.3 – 2.1)	750 (51.7)	3/8"	Zinc	Tungsten carbide	93656-1	0 – 60 (0 – 4)
651790-A1C-B	20 – 60 (1.4 – 4.1)	750 (51.7)	3/8"	Zinc	Tungsten carbide	93656-1	0 – 60 (0 – 4)
651790-A1D-B	50 – 200 (3.4 – 13.8)	750 (51.7)	3/8"	Zinc	Tungsten carbide	93887	0 – 300 (0 – 20)
651790-A1R-B	30 – 200 (2.1 – 13.8)	750 (51.7)	3/8"	Zinc	Tungsten carbide	No gauge	N/A
651790-A3B-B	5 – 30 (0.3 – 2.1)	750 (51.7)	3/8"	300 Series stainless	Tungsten carbide	93657-1	0 – 60 (0 – 4)
651790-A3C-B	20 – 60 (1.4 – 4.1)	750 (51.7)	3/8"	300 Series stainless	Tungsten carbide	93657-1	0 – 60 (0 – 4)
651790-A3D-B	50 – 200 (3.4 – 13.8)	750 (51.7)	3/8"	300 Series stainless	Tungsten carbide	93888	0 – 300 (0 – 20)
651790-A3R-B	30 – 200 (2.1 – 13.8)	750 (51.7)	3/8"	300 Series stainless	Tungsten carbide	No gauge	N/A
651790-A4B-B	5 – 30 (0.3 – 2.1)	500 (34.5)	3/8"	300 Series stainless	300 Series stainless	93657-1	0 – 60 (0 – 4)
651790-A4C-B	20 – 60 (1.4 – 4.1)	500 (34.5)	3/8"	300 Series stainless	300 Series stainless	93657-1	0 – 60 (0 – 4)
651790-A4D-B	50 – 200 (3.4 – 13.8)	500 (34.5)	3/8"	300 Series stainless	300 Series stainless	93888	0 – 300 (0 – 20)
651790-A4R-B	30 – 200 (2.1 – 13.8)	500 (34.5)	3/8"	300 Series stainless	300 Series stainless	No gauge	N/A
651790-B1C-B	20 – 60 (1.4 – 4.1)	750 (51.7)	3/8"	Zinc	Tungsten carbide	93656-1	0 – 60 (0 – 4)
651790-B1D-B	30 – 200 (2.1 – 13.8)	1,250 (86.2)	3/8"	Zinc	Tungsten carbide	93887	0 – 300 (0 – 20)
651790-B1E-B	100 – 800 (6.9 – 55.2)	800 (55.2)	3/8"	Zinc	Tungsten carbide	93503-1	0 – 1,000 (0 – 70)
651790-B1R-B	30 – 200 (2.1 – 13.8)	500 (34.5)	3/8"	Zinc	Tungsten carbide	No gauge	N/A
651790-B2E-B	100 – 800 (6.9 – 55.2)	800 (55.2)	3/8"	300 Series stainless	400 Series stainless	93504-1	0 – 1,000 (0 – 70)
651790-B3D-B	30 – 200 (2.1 – 13.8)	1,250 (86.2)	3/8"	300 Series stainless	Tungsten carbide	93888	0 – 300 (0 – 20)
651790-B3E-B	100 – 800 (6.9 – 55.2)	1,250 (86.2)	3/8"	300 Series stainless	Tungsten carbide	93504-1	0 – 1,000 (0 – 70)
651790-B4D-B	30 – 200 (2.1 – 13.8)	500 (34.5)	3/8"	300 Series stainless	300 Series stainless	93888	0 – 300 (0 – 20)
651790-B4E-B	100 – 800 (6.9 – 55.2)	1,250 (86.2)	3/8"	300 Series stainless	300 Series stainless	93504-1	0 – 1,000 (0 – 70)
651790-B4R-B	30 – 200 (2.1 – 13.8)	500 (34.5)	3/8"	300 Series stainless	300 Series stainless	No gauge	N/A
651790-B5R-B	30 – 200 (2.1 – 13.8)	500 (34.5)	3/8"	300 Series stainless	300 Series stainless	No gauge	N/A



3/8" Ports,
Standard Flow
for 651790-A3D-B



3/8" Ports,
Standard Flow, Remote
Model
for 651790-A3R-B

1/4" Ports

Model	Regulated Pressure Range psi (bar)	Maximum Inlet Pressure psi (bar)	Port Size	Housing Base	Seat
27520-000	5 – 125 (0.3 – 8.5)	750 (51.7)	1/4"	Zinc	Tungsten carbide
27520-100	0 – 50 (0 – 3.4)	750 (51.7)	1/4"	Zinc	Tungsten carbide
27520-200	10 – 250 (0.6 – 17.1)	750 (51.7)	1/4"	Zinc	Tungsten carbide
27520-400	0 – 30 (0 – 2.0)	750 (51.7)	1/4"	Zinc	Tungsten carbide



27520-200

Back Pressure Regulators

Model	Regulated Pressure Range psi (bar)	Maximum Inlet Pressure psi (bar)	Port Size	Housing Base	Seat	Gauge	Pressure Range psi (bar)
651781-B1B-B	100 – 3,000 (6.9 – 206.9)	3,000 (206.9)	3/8"	Carbon steel	Tungsten carbide	No	
651781-B3B-B	100 – 3,000 (6.9 – 206.9)	3,000 (206.9)	3/8"	300 Series stainless	Tungsten carbide	No	
651781-C1B-B	100 – 3,000 (6.9 – 206.9)	3,000 (206.9)	3/4"	Carbon steel	Tungsten carbide	No	
651781-C3B-B	100 – 3,000 (6.9 – 206.9)	3,000 (206.9)	3/4"	300 Series stainless	Tungsten carbide	No	
651791-B1D-B	0 – 200 (0 – 13.8)	1,250 (86.2)	3/8"	Zinc carbide	Tungsten	93887	0 – 300 (0 – 20)
651791-B1E-B	0 – 800 (0 – 55.2)	800 (55.2)	3/8"	Zinc	Tungsten carbide	93503-1	0 – 1,000 (0 – 70)
651791-B3D-B	0 – 200 (0 – 13.8)	1,250 (86.2)	3/8"	300 Series stainless	Tungsten carbide	93888	0 – 300 (0 – 20)
651791-B3E-B	0 – 800 (0 – 55.2)	1,250 (86.2)	3/8"	300 Series stainless	Tungsten carbide	93504-1	0 – 1,000 (0 – 70)
651791-B4D-B	0 – 200 (0 – 13.8)	500 (34.5)	3/8"	300 Series stainless	300 Series stainless	93888	0 – 300 (0 – 20)
651791-C3D-B	0 – 200 (0 – 13.8)	200 (13.8)	1-1/4"	300 Series stainless	Tungsten carbide	93888	0 – 300 (0 – 20)
651791-C4D-B	0 – 200 (0 – 13.8)	200 (13.8)	1-1/4"	30.0 Series stainless	300 Series stainless	93888	0 – 300 (0 – 20)



(651781-B1B-B)

1-1/4" Ports
(651791-B1E-B)

Mounting Bracket

Part Number	Description
94806	MOUNTING BRACKET
Features:	<ul style="list-style-type: none"> • Permits wall-mounting of I.D.L. downstream and back pressure fluid regulators • Use of mounting bracket alleviates strain on plumbing system from weight of fluid and regulator
Used With:	<ul style="list-style-type: none"> • 651780-XXX-B, 651790-XXX-B and 651791-XXX-B regulators, less remote models



High and Low Pressure

Low-Pressure Gauges

Model	Material	Maximum Gauge Pressure psi (bar)	Thread Size	Used With
29975	Brass or aluminum	160 (11)	1/8" (M)	651780-X-B, 651781-X-B, 651790-X-B, and 651791-X-B regulators
29882	Brass or aluminum	60 (4)	1/8" (M)	651780-X-B, 651781-X-B, 651790-X-B, and 651791-X-B regulators
29883	Brass or aluminum	160 (11)	1/8" (M)	651780-X-B, 651781-X-B, 651790-X-B, and 651791-X-B regulators
100067	Brass or aluminum	160 (11)	1/4" (M)	651780-X-B, 651781-X-B, 651790-X-B, and 651791-X-B regulators
100083	Brass or aluminum	300 (21)	1/4" (M)	651780-X-B, 651781-X-B, 651790-X-B, and 651791-X-B regulators
93504-1	Stainless steel	0 – 1,000 (0 – 70)	1/4" (M)	651780-X-B, 651781-X-B, 651790-X-B, and 651791-X-B regulators

High-Pressure Gauges

Model	Material	Maximum Gauge Pressure psi (bar)	Thread Size	Used With
93505-1	Rear-mounted, non-stainless steel	0 – 3,000 (0 – 204)	1/4" (M)	Required when attaching gauge to 651780-X-B and 651781-X-B high-pressure fluid regulators
93506-1	Rear-mounted, stainless steel	0 – 3,000 (0 – 204)	1/4" (M)	Required when attaching gauge to 651780-X-B and 651781-X-B high-pressure fluid regulators

High-Pressure Gauge Adapters

Model	Port Size	Type	Used With
92968	3/8"	Dual-outlet ports	Required when attaching gauge to 651780-X-B and 651781-X-B high-pressure fluid regulators, when using the 93505-1 and 93506-1 gauges



Extrusion

Manual Extrusion Guns

Model Number	Description	Max Fluid Pressure psi (bar)	Fluid Inlet in	Fluid Outlet I.D. & Thread in (mm)
651500	Flow Gun: Aluminum body with tungsten carbide seats. Order 66541-XX Extrusion Nozzle Kit separately. Used to extrude material over 200,000 cPs.	7500 (517)	3/8" (F)	1/4" (6) & 11/16-16 (M)
651533	Flow Gun: Wetted parts of 316 series stainless steel with tungsten carbide seats. Order 66541-XX Extrusion Nozzle Kit separately.	5000 (345)	1/4" NPS(M)	15/16" (2.3) & 11/16-16 (M)
641523-1	Flow Gun: Wetted parts of 300 Series stainless steel with Teflon packings. Order 76751 Adapter and 66541-XX Extrusion Nozzle Kit separately.	3000 (207)	3/8" (F)	1/4" (6) & 1/4" NPT(F)



651533



641523-1

(Shown with 66541-XX)

Automatic Extrusion Guns

Model Number	Description	Max Working Pressure psi (bar)	Material Inlet Size in (mm)	Material Outlet Size in (mm)	Air Inlet Size in (mm)	Min Air Pressure Required psi (bar)
651511	Flow Gun: Requires 4-way air valve to open and close. Adjusting screw varies stroke length. Secures to 1/2" diameter rod by Allen screw. Aluminum body with tungsten carbide seats. Order 66541-XX Extrusion Nozzle Kit separately.	5,000 (345)	3/8 (9.5) NPT (F) (2)	11/16 - 16 UN-2A (17.4)	(2) 1/8 (3.1) NPT (F)	50 (3.4) at 2000 PSI (138 bar) fluid pressure
651513-11-B	Flow Gun: Has air open, spring return actuator. Requires 3-way air valve to open. Adjusting screw varies stroke length. Secures to 1/2" diameter rod by Allen screw. 316 stainless steel body with tungsten carbide seat. Order 66541-XX Extrusion Nozzle Kit separately.	5,000 (345)	1/4 - 18 (6.3) NPS (M)	11/16 - 16 (17.4) (M)	1/8 - 27 (3.1) NPT (F) -1	50 (3.4) at 2000 PSI (138 bar) fluid pressure
651536-1	Snuff-Back Gun: High flow automatic dispensing gun is designed to handle high-viscosity materials. Requires a 4-way air valve to open and close.	5,000 (345)	3/8 - 18 (9.5) NPT (F)	1/4 - 18 (6.3) NPT (F)	(2) 1/8 - 27 (3.1) NPT (F)	50 (3.4) at 2000 PSI (138 bar) fluid pressure
651537-1	Flow Gun: Similar to 651511 except with carbon-steel body and tungsten carbide ball and seat.	5,000 (345)	(2) 3/8 (9.5) NPT (F)	3/8 - 18 (9.5) NPT (F)	(2) 1/8 - 27 (3.1) NPT (F)	50 (3.4) at 2000 PSI (138 bar) fluid pressure



651511



651513



651500

Extrusion Gun Nozzle Kits

Model Number in (mm)	Orifice Diameter in (mm)	Model Number	Orifice Diameter in (mm)	Model Number	Orifice Diameter in (mm)
76751	Adapter: 1/4 NPT (M) to 11/16-16 (M) adapts 66541-XX Extrusion Nozzle Kit to fluid outlet for 641523-1 Flow Gun.				
66541-XX	Extrusion Nozzle Kit: Used on manual or automatic extrusion guns. Hardened steel assembly includes nozzle and cap. 11/16-16 UN(F).				
66541-3	0.031" (.787)	66541-9	0.093" (2.36)	66541-17	0.172" (4.37)
66541-4	0.046" (1.17)	66541-12	0.125" (3.18)	66541-18	0.187" (4.75)
66541-6	0.063" (1.60)	66541-15	0.156" (3.96)	66541-25	0.250" (6.35)
				66541-37	0.375" (9.53)





Airless

Manual Airless Guns

Model Number	Description	Max Fluid Pressure psi (bar)	Fluid Inlet in	Fluid Outlet I.D. & Thread in (mm)
651533	Airless Gun: Wetted parts of 316 stainless steel with tungsten carbide seats. Used for airless application of paints, lacquers and other light fluids. Order TC-XXXX airless spray tip separately.	5,000 (345)	1/4" NPS(M)	15/16" (2.3) & 11/16-16 (M)
651500-1	Airless Gun: Aluminum body with tungsten carbide seats. Used for airless application of materials over 200,000 cPs. Includes 66504 tip guard and nut. Order TC-XXXX spray tip separately.	7500 (517)	3/8" NPT(F)	1/4" (6) & 11/16-16 (M)



651533



651500-1

Automatic Airless Guns

Model Number	Description	Max Fluid Pressure psi (bar)	Fluid Inlet in	Fluid Outlet I.D. & Thread in (mm)	Air Inlet/Outlet Inches NPT	Min. Air Pressure to open psi (bar)
651511-1	Airless Gun: Requires 4-way air valve to open & close. Adjusting screw varies stroke length. Secures to 1/2" diameter rod by Allen screw. Aluminum body with tungsten carbide seats. Includes 66504 tip guard and nut. Order TC-XXXX spray tip separately.	5000 (345)	(2) 3/8 NPT(F)	1/4" (6) & 11/16-16(M)	(2) 1/8 (F)	50 (3.4) at 2000-psi (138-bar) fluid pressure
651513-12-B	Airless Gun: Has air open, spring return cylinder. Requires 3-way air valve to open. Adjusting screw varies stroke length. Secure to 1/2" diameter rod with Allen screw. 316 stainless body with tungsten carbide seat. Includes 66504 tip guard and nut. Order TC-XXXX spray tip separately.	5000 (345)	(1) 1/4 NPS(M)	15/16" (2.3) & 11/16-16 (M)	(1) 1/8 (F)	50 (3.4) at 2000-psi (138-bar) fluid pressure



651511-1



651513-12-B



Airless

Airless Spray Tips

Part Number	-D Models	Equivalent Orifice	Pattern Width in (mm)	Flow Rate gpm @ Fluid psi			
				500	1,000	1,500	2,000
TC1325	-	0.013	5.5" (140)	0.09	0.12	0.15	0.18
TC1550	-D	0.015	10.0" (254)	0.12	0.16	0.1	0.23
TC1850	-D	0.018	10.0" (254)	0.18	0.25	0.3	0.36
TC1865	-D	0.018	13.0" (330)	0.18	0.25	0.3	0.36
TC1880	-D	0.018	15.0" (381)	0.18	0.25	0.3	0.36
TC2140	-D	0.021	8.5" (216)	0.24	0.33	0.41	0.47
TC2650	-D	0.026	12.0" (305)	0.35	0.5	0.61	0.71
TC3195	-	0.031	21.5" (546)	0.53	0.75	0.92	1.1
TC3650	-	0.036	12.0" (305)	0.71	1	1.2	1.4
TC4195	-	0.041	21.5" (546)	0.88	1.2	1.5	1.8
TC4340	-	0.043	9.0" (229)	1.1	1.5	1.8	2.1
TC4365	-	0.043	15.0" (381)	1.1	1.5	1.8	2.1
TC6265	-	0.062	15.0" (381)	2.1	3	3.7	4.2

Part Number	Description
66504	TIP GUARD AND NUT
Features	Secure TC-XXX tip to gun; guard required on airless applications. Order tips separately.
Used With	• All manual/automatic spray guns
651555-B	QUICK CLEAN
Features	Spray tip locked in operating position until reversed with lever for cleaning. For spraying heavy-viscosity material. Order separately.
Used With	• All manual/automatic spray guns
651551	QUICK CLEAN
Features	Spray tip locked in operating position until reversed with lever for cleaning. For spraying heavy-viscosity material. Order TC-XXXX spray tip separately.
Used With	• 651500-1 guns • NOTE: To adapt 651551 to fit 651533, order 76555 pilot, 92367 retaining nut, Y167-1-1/8" (M) x 1/4" (F) adapter
65030-1-B	SWIVEL
Features	1/4" NPT(M) x 1/4" NPS (F); swivels 360°. No filter included.
Used With	• All manual/automatic spray guns
65030-X-B	SWIVEL AND FILTER ASSEMBLY
Features	1/4" NPT(M) x 1/4" NPS(F); swivels 360°. 6700-psi (462.3-bar) maximum working pressure
Used With	• All manual / automatic spray guns
65030-1-B	Swivel, no filter
65030-5-B	Swivel, 100-mesh stainless steel filter
65030-9-B	Swivel, 60-mesh stainless steel filter

Model Number Descriptor

TC 18 65 -D

TC = Tungsten carbide

-D tips used only with 651555-B quick clean

18 = 0.018 orifice diameter

65 = 65° spray pattern



TC1850

Equivalent Orifice

Airless tip orifices are elliptical in shape. The term "equivalent orifice diameter" refers to the circular orifice diameter which will provide the same flow rate as the elliptical orifice. The equivalent orifice diameter does not indicate actual orifice dimensions.

Pattern Width

This dimension is the nominal pattern width of each tip when tested on a coating material of 20 seconds: Number 4 Zahn cup viscosity at 1,500 psi at a 12" distance from the tip.

Flow Rate in gpm

The flow rates of Ingersoll Rand / ARO Piston Pumps airless tips are given as gpm flow on water at pressures shown. Capacities will vary to some degree on other materials.



651555-B



651551

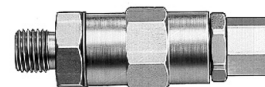

65030-1

Non-Metered and Metered

Non-metered Fluid Control Handles

Model	Description	Max working pressure psi (bar)	Fluid inlet NPT (F) in (mm)	Fluid outlet
MOTOR OIL, GEAR OIL, TRANSMISSION FLUID				
HIGH-VOLUME				
635193	Has flexible rubber hose with non-drip nozzle; use with 1:1 and 3:1 pumps; Non-drip tip	600 (41)	3/4" (19.1)	629212
STANDARD-VOLUME				
635392	Has flexible rubber hose, built-in swivel and filter, and non-drip nozzle; non-drip tip	1,000 (69)	1/2" (12.7)	60164
635399	Has flexible rubber hose, built-in swivel, and right-angle non-drip nozzle; non-drip tip	1,000 (69)	1/2" (12.7)	70790
WATER, ANTIFREEZE				
635129	Radiator bibb	300 (21)	1/4" (6.3)	Non-drip tip



635193



635399



635392

Digital, Metered Fluid Control Handles

Our metered control handle features a patented oval gear wheel design for precise and reliable measurement. Its digital LCD readout operates on two standard alkaline batteries.

- Lightweight
- Precise
- Fast reset
- Totalizes

Model	Max flow rate gpm (L)	Meter / totalizing increments	Max working pressure psi (bar)	Fluid inlet NPT (F) in (mm)	Fluid outlet
METERED, RIGID NOZZLE MODELS					
635390-11	4 (15)	Pints / gallons	1,000 (69)	1/2" (12.7)	Non-drip tip
635390-22	4 (15)	Quarts / gallons	1,000 (69)	1/2" (12.7)	Non-drip tip
635390-33	4 (15)	LITERS / LITERS	1,000 (69)	1/2" (12.7)	NON-DRIP TIP
NON-METERED, RIGID NOZZLE MODELS (HANDLE AND NOZZLE ONLY)					
635391-11	4 (15)	-	1,000 (69)	1/2" (12.7)	NON-DRIP TIP
METERED, FLEXIBLE NOZZLE MODELS					
635390-1	4 (15)	Pints / gallons	1,000 (69)	1/2" (12.7)	Non-drip tip
635390-2	4 (15)	Quarts / gallons	1,000 (69)	1/2" (12.7)	Non-drip tip
635390-3	4 (15)	LITERS / LITERS	1,000 (69)	1/2" (12.7)	NON-DRIP TIP
NON-METERED, FLEXIBLE NOZZLE MODELS (HANDLE AND NOZZLE ONLY)					
635391-1	4 (15)	-	1,000 (69)	1/2" (12.7)	Non-drip tip



635390-X



635390-XX



635391-11



635391-1

Digital, Metered Fluid Control Handles (continued)

Model	Max flow rate gpm (L)	Meter / totalizing increments	Max working pressure psi (bar)	Fluid inlet NPT (F) in (mm)
METER ONLY				
635190-1	4 (15)	Pints / gallons	1,000 (69)	1/2" (12.7)
635190-2	4 (15)	Quarts / gallons	1,000 (69)	1/2" (12.7)
635190-3	4 (15)	Liters / liters	1,000 (69)	1/2" (12.7)
METER, CONTROL HANDLES (WITHOUT NOZZLES)				
635390-30	4 (15)	Liters / liters	1,000 (69)	1/2" (12.7)



635190-X
Order protective boot
74066 separately.

Metered Fluid Control Handles

Model	Units Of measure	Totalizing increments	Working pressure psi (bar)	Inlet size in (mm)	Fluid outlet
PRESET, DIGITAL METERED FLOW CONTROL					
Preset unit automatically shuts off when set quantity of fluid is delivered and meter indicator returns to zero. Totalizer registers up to 9,999 units.					
635360-2	Quarts	Gallons	1,000 (69)	1/2" (12.7)	Non-drip flex extension
635360-22	Quarts	Gallons	1,000 (69)	1/2" (12.7)	Non-drip rigid extension
PRESET, METERED FLOW CONTROL					
Preset unit automatically shuts off when set quantity of fluid is delivered and meter indicator returns to zero. Totalizer registers up to 9,999 units.					
635364	1 to 60 quarts	Gallons	1,000 (69)	1/2" (12.7)	9/16" (14.3 mm) diameter non-drip tip
635365	1 to 60 gallons	Gallons	1,000 (69)	1/2" (12.7)	9/16" (14.3 mm) diameter non-drip tip
635367	1 to 60 liters with auto shut-off	Liters	1,000 (69)	1/2" (12.7)	9/16" (14.3 mm) diameter non-drip tip



635360-2

635365

Non-drip Nozzle / Hose

Model	Description	Fluid inlet NPT in (mm)	Length in (mm)	Max working pressure psi (bar)
MOTOR OIL, GEAR OIL, TRANSMISSION FLUID				
629212	Non-drip nozzle / hose	3/4" (19.1)	12" (305)	900 (62)
629226	Non-drip nozzle / hose	1/2" (12.7)	11" (279)	900 (62)
629516	Non-drip nozzle / hose	1/2" (12.7)	13" (330)	1,000 (69)
629521	Right-angle nozzle / hose	1/2" (12.7)	15" (381)	1,000 (69)
6786	Right-angle, rigid, non-drip nozzle	1/4" (6.3)	6-1/2" (165)	1,000 (69)
60798	Rigid, non-drip nozzle	1/2" (12.7)	5-1/2" (133)	1,000 (69)
NOZZLE, FLEXIBLE HOSE, WITH NON-DRIP TIP				
629245-1	Flexhose, non-drip tip	1/2" (12.7)	15" (381)	1,000 (69)
NOZZLE, RIGID TUBE WITH NON-DRIP TIP				
629245-2	Rigid tube, non-drip tip	1/2" (12.7)	13" (330)	1,000 (69)



629212

629226

629516

629521

6786

High-pressure Grease Control Handles

Model	Description	Max working pressure psi (bar)	Fluid inlet NPT (F) in (mm)	Fluid outlet in (mm)
GREASE CONTROL HANDLES				
636101	Dispenses lubrication at line pressure for lubricating grease fittings; does not include nozzle or hydraulic coupler; for applications requiring high-flow capacity; remove the 1/8" (3.2 mm) (M) x 3/8" (9.5 mm) (M) adapter for 3/8" (9.5 mm) (F) porting	7,500 (517)	3/8" (9.5) (F)	11/16" – 16 (17.5) (M) or 1/8" (3.2) NPT (F)
636111	Dispenses lubricant at line pressure for lubricating grease fittings; includes inlet material filter and curved nozzle with hydraulic coupler; remove the 1/8" (3.2 mm) (M) x 3/8" (9.5 mm) (M) adapter for 3/8" (9.5 mm) (F) porting	7,500 (517)	1/8" (3.2) (M) or 3/8" (9.5) (F)	Hydraulic coupler
636103	High-pressure booster handle delivers line pressure for normal lubrication; trigger booster feature delivers 10,000 psi (689 bar) to loose tougher fittings; includes curved nozzle with hydraulic coupler, inlet material filter and manual pressure vent for easy disconnection; do not use with whip hose	7,500 (517)	1/8" (3.2) (M) or 3/8" (9.5) (F)	Hydraulic coupler
WHIP HOSES FOR GREASE CONTROL HANDLES*				
629742	Extra-long, wire braid (624201-02) whip hose with hydraulic coupler and swivel; overall length of 29-1/2" (749 mm); for use with coupler 636111 high-pressure control handle; allows operator to access hard-to-reach fittings	5,000 (345)	1/8" (3.2) (F)	636046 hydraulic

*WARNING: Not for use with 636103 high-pressure booster handle.



Specialty Application Control Handle

Model	Description
WATER, ANTIFREEZE, WINDSHIELD FLUID	
635129	Fluid dispensing nozzle — 635129 bibb with trigger 1/4" (6.3 mm) NPT(F) inlet, zinc die casting with brass, and nitrile seals for water or oil service; radiator-type bibb has 1/4" (6.3 mm) fluid inlet and non-drip tip



635129

Heaters Fluid Heaters

Fluid Heaters and Accessories

Part Number	Volts AC	Amps	Heater watts	Heater Accuracy °F (°C)	Rise Over Ambient °F (°C)	Recovery gph (L)	Working Press psi (bar)	Inlet/Outlet NPT	
651747-1-B	120	16.6	2,000	+/- 3-1/2° (+/- 1.9°)	100° (38°)	15 (56.8)	5,000 (345)	1/2" (F)	
651747-2-B	240	8.3	2,000	+/- 3-1/2° (+/- 1.9°)	100° (38°)	15 (56.8)	5,000 (345)	1/2" (F)	
651747-3-B	440	4.5	2,000	+/- 3-1/2° (+/- 1.9°)	100° (38°)	15 (56.8)	5,000 (345)	1/2" (F)	
Part Number	Description								Used With
MOUNTING BRACKET									
66258	Bracket assembly with appropriate mounting holes to affix heater to vertical substrate								651747-X



651747-X-B

Low-Profile Dispensing Valves

Spray valves for the atomization of low-viscosity fluids

These compact, air-operated, automatic spray valves provide air-atomized application of low-viscosity fluids. They are designed to be used with either supply pumps or pressure tanks. Several unique design features seal the material from outside air and moisture and prevent premature curing of material, which allows for either continuous or intermittent use and reduces the need for daily cleanup.

Compact design provides mounting versatility

The narrow dimensions, block shape, and hose placement allow installation in narrow, recessed areas. Multiple valves can be grouped together in an area normally occupied by a single conventional spray valve.

Spray Patterns

Unique spray patterns matched to application requirements

To meet the needs of your individual application, both flat and round spray patterns are available. For wide surface coverage with minimum film thickness, flat spray models are available in both 90 degree and 45 degree spray patterns. For a more focused pattern with a thicker film build or a conical substrate, the round spray models are the appropriate choice.

Extrusion valves for precise applications of bead patterns

For applications that require a precise bead of material rather than a sprayed coating, several extrusion valves are available. Like the spray valves, separate air pressure and material flow adjustments provide regulation of emissions for material savings and precise, accurate patterns.

Multiple valves can be grouped together to achieve a multiple-bead pattern.

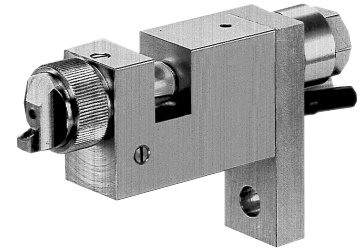

407442-08-4

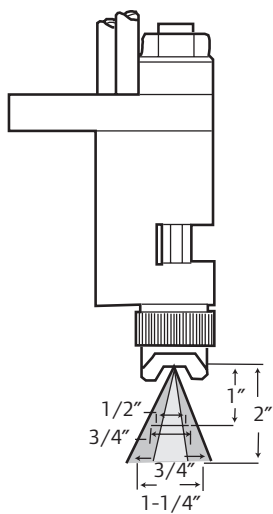

Flat spray
90° pattern

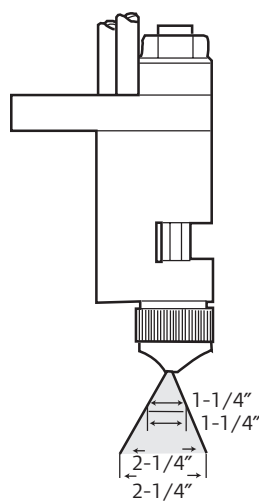

Flat spray
45° pattern

Part Number	Material Pressure psi (bar)	Control Air psi (bar)	Atomizing Air psi (bar)
407442-XX	15 (1.0)	55 (3.8)	20 (1.4)
	30 (2.1)	90 (6.2)	35 (2.4)

Part Number	Material Pressure psi (bar)	Control Air psi (bar)	Atomizing Air psi (bar)
407442-XX-4	15 (1.0)	55 (3.8)	20 (1.4)
	35 (2.1)	90 (6.2)	35 (2.4)

Low-Profile Dispensing Valves

Part Number	Tip Diameter mm	Fluid Inlet NPT(M)	Atomizing Air Inlet NPT(M)	Control Air Inlet NPT(M)	Minimum Control Air Required psi (bar)	Max Fluid Operating Pressure psi (bar)	Recommended Range Atomizing Air Pressure psi (bar)
FLAT SPRAY — 90° PATTERN							
407442-8	0.8	1/4"	1/4"	1/8"	55 (3.7)	180 (12)	7.5 – 37.5 (0.5 – 2.5)
407442-10	1	1/4"	1/4"	1/8"	55 (3.8)	180 (12)	7.5 – 37.5 (0.5 – 2.5)
407442-15	1.5	1/4"	1/4"	1/8"	55 (3.7)	180 (12)	7.5 – 37.5 (0.5 – 2.5)
FLAT SPRAY — 45° PATTERN							
407442-8-4	0.8	1/4"	1/4"	1/8"	55 (3.7)	180 (12)	7.5 – 37.5 (0.5 – 2.5)
407442-10-4	1	1/4"	1/4"	1/8"	55 (3.7)	180 (12)	7.5 – 37.5 (0.5 – 2.5)
407442-15-4	1.5	1/4"	1/4"	1/8"	55 (3.7)	180 (12)	7.5 – 37.5 (0.5 – 2.5)
ROUND SPRAY — FOCUSED PATTERN							
407443-8	0.08	1/4"	1/4"	1/8"	90 (6)	90 (6)	7.3 – 37.5 (0.5 – 2.5)
407443-12	1.2	1/4"	1/4"	1/8"	90 (6)	90 (6)	7.3 – 37.5 (0.5 – 2.5)
407443-20	2	1/4"	1/4"	1/8"	90 (6)	90 (6)	7.3 – 37.5 (0.5 – 2.5)
ROUND SPRAY — DIFFUSED PATTERN							
407441-8	0.08	1/4"	1/4"	1/8"	55 (3.7)	180 (12)	7.3 – 37.5 (0.5 – 2.5)
407441-10	1	1/4"	1/4"	1/8"	55 (3.7)	180 (12)	7.3 – 37.5 (0.5 – 2.5)
407441-15	1.5	1/4"	1/4"	1/8"	55 (3.7)	180 (12)	7.3 – 37.5 (0.5 – 2.5)
EXTRUSION VALVES							
407444-3	0.3	1/4"	1/4"	1/4"	90 (6)	1,000 (69)	None required
407444-5	0.5	1/4"	1/4"	1/4"	90 (6)	1,000 (69)	None required
407444-7	0.7	1/4"	1/4"	1/4"	90 (6)	1,000 (69)	None required

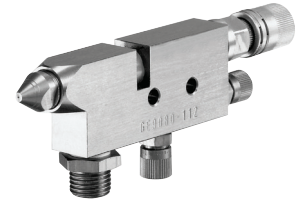

407444-3

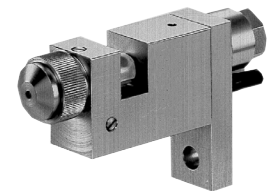

407441-8

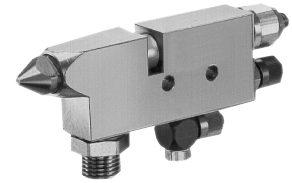

407444-3

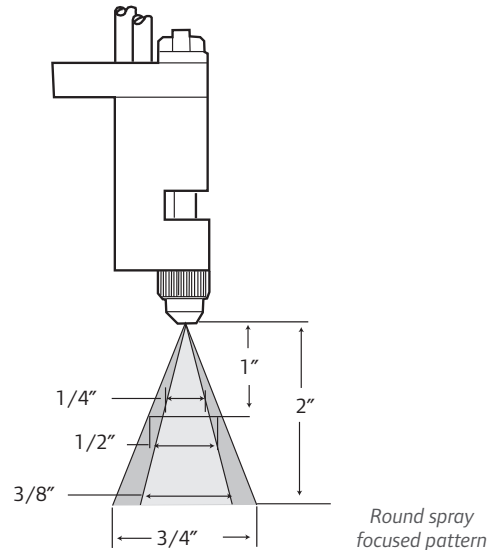
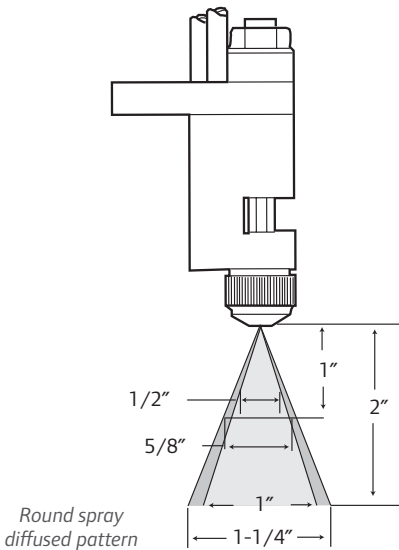

Part Number	Material Pressure psi (bar)	Control Air psi (bar)	Atomizing Air psi (bar)
407441-XX	15 (1.0)	55 (3.8)	20 (1.4)
407446-XX	30 (2.1)	90 (6.2)	35 (2.4)

Part Number	Material Pressure psi (bar)	Control Air psi (bar)	Atomizing Air psi (bar)
407443-XX	15 (1.0)	100 (6.9)	60 (4.1)
	30 (2.1)	100 (6.9)	20 (1.4)

Material Filters

Material Filters

Part Number	Max Fluid Pressure psi (bar)	Filter		Filter Inlet size NPT (qty)	Filter Outlet size NPT (qty)
		Mesh	Microns		
1/4" FLUID INLET — CARBON STEEL CONSTRUCTION					
651412	5,000 (345)	70	200	1/4" F (2) Bottom swivel	1/4" F (3)
651412-8	5,000 (345)	100	149	1/4" F (2)	1/4" F (3)
1/2" FLUID INLET — STAINLESS STEEL CONSTRUCTION (PASSIVATED)					
651422-40	6,000 (414)	40	375	1/2" F (2)	1/2" F (1)
651422-70	6,000 (414)	70	200	1/2" F (2)	1/2" F (1)
651422-100	6,000 (414)	100	149	1/2" F (2)	1/2" F (1)
1/2" FLUID INLET — CARBON STEEL CONSTRUCTION (E-NICKEL PLATED)					
651420-40	6,000 (414)	40	375	1/2" F (2)	1/2" F (1)
651420-70	6,000 (414)	70	200	1/2" F (2)	1/2" F (1)
651420-100	6,000 (414)	100	149	1/2" F (2)	1/2" F (1)
651421-70	6,000 (414)	70	200	1" (2) 1/2" (1)	3/4" F (1)
1" FLUID INLET — CARBON STEEL CONSTRUCTION (E-NICKEL PLATED)					
651418-40-B	6,000 (414)	40	375	1" F (2)	3/8" F (3)
651418-70-B	6,000 (414)	70	200	1" F (2)	3/8" F (3)
651418-100-B	6,000 (414)	100	149	1" F (2)	3/8" F (3)

Part Number	Description
94256	OUTLET REDUCING ADAPTER
Features	• For mounting material filter 1" NPT(M) x 1/2" NPT(M)
Used With	• Integrity 2-ball pumps

Inlet Material Filters

Model	Description	For use with
651830	Filter element keeps foreign matter from entering lower pump end	Adapts to 91020-1 or -2 pipe extension.

Material Filter Screens

Part Number	Screen Mesh	Filter Used With
91192-2	70	651412
91192-3	100	651412
93944-40	40	651420 651422
93944-70	70	651420 651422
93944-100	100	651420 651422
93945-40	40	651418
93945-70	70	651418
93945-100	100	651418



651412-X



651418-XX-B



651420-XX-B



651830

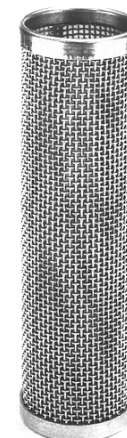

93944-70

Hose Material	Description
BUNA N	
Features	Buna N is highly resistant to petroleum-based oils and many cleaners; hoses incorporating a Buna N tube make excellent air hoses when lubrication is required in the air line
Recommended For	Ammonia solutions, petroleum oils and fluids, water, silicone greases and oils, di-ester base lubricants, ethylene glycol base fluids, abrasive material, corn oil, ethylene alcohol, soap solution
Not Recommended For	Acetate solvents, ketones (MEK, acetone), strong acids, ozone, automatic brake fluid, benzene, carbon disulfide, ethylene chloride
GRS	
Features	GRS (Government Rubber Styrene) has superior wear characteristics; high tensile properties, good abrasion, and moisture resistance makes a fine air hose
Recommended For	Automatic brake fluid, alcohols, water, use as an air hose
Not Recommended For	Ozone, petroleum oil, many chemicals, abrasive material
POLYSULFIDE (THIOKOL)	
Features	Highly resistant to most paint solvents; suitable for use as a flexible supply line carrying paint, latex materials, gasoline, and oil
Recommended For	4-1/4" air motor and 6" air motor; 2-ball and 4-ball pumps (including Integrity/Stinger pumps)
Not Recommended For	Automatic brake fluid, alcohols, non-oxidizing acids, oils, ketones (MEK, acetone)
NEOPRENE	
Features	Good resistance to ozone, sunlight, and oxidation; performs well in contact with oils, is heat and flame-resistant, and has good tensile strength & resilience
Recommended For	Refrigerants (freons), petroleum oil, mild acids, silicate ester lubricants, abrasive material, calcium chloride
Not Recommended For	Phosphate ester fluids, ketones (MEK, acetone), benzene
NYLON	
Features	Nylon is tough and retains its shape at elevated temperatures; is highly resistant to abrasion and to the effects of most chemicals; unaffected by oil, enamel, or lacquer solvents when used as a fluid supply hose
Recommended For	Lubricating oils and grease, aliphatic and aromatic hydro-carbons, common esters, ketones, ethers, alkalies, abrasive material, benzene, butyl alcohol, carbon tetrachloride
Not Recommended For	Strong acids, RTV, creosote, oxidizing agents

For further hose material compatibility, consult the ARO® Material Compatibility Guide, Form Number 8677-P.

Fluid Hoses

RTV/Moisture Lok™ Hoses

Part Number	Fitting Thread Size	Hose Materials Tube	Cover	Lengths ft (m)	psi (bar)
3/8" I.D., 11/16" O.D., POLYESTER BRAID					
628081-10	3/8" NPTM x 3/8" NPTM	Polymer	Polyurethane	10' (3.0)	2250 (190)
628081-15	3/8" NPTM x 3/8" NPTM	Polymer	Polyurethane	15' (4.5)	2250 (190)
1/2" I.D., 13/16" O.D., POLYESTER BRAID					
628084-5	1/2" NPTM x 1/2" NPTM	Polymer	Polyurethane	5' (1.5)	2000 (138)
628084-10	1/2" NPTM x 1/2" NPTM	Polymer	Polyurethane	10' (3.0)	2000 (138)
628084-25	1/2" NPTM x 1/2" NPTM	Polymer	Polyurethane	25' (7.6)	2000 (138)

The material characteristic chart indicates what type of hose material is recommended for specific fluids. The following charts list hoses in order of use, size, tube, cover materials, and maximum working pressure. In selecting the proper hose, be sure the hose material and fluid is compatible and that the maximum working pressure will not be exceeded in the application. Standard length hoses, which are a stock item ready for shipment, are listed in the "standard lengths" column of the selection chart on the following page.

Low-Pressure Air and Fluid Hoses

Part Number	Fitting Thread Size	Hose Materials Tube	Cover	Lengths ft (m)	psi (bar)
1/2" I.D., 27/32" O.D., 1 FABRIC BRAID					
621501-2	1/2" NPTM x 1/2" NPTM	GRS	GRS	2' (.6)	125 (9)
621501-3	1/2" NPTM x 1/2" NPTM	GRS	GRS	3' (.9)	125 (9)
621501-5	1/2" NPTM x 1/2" NPTM	GRS	GRS	5' (1.5)	125 (9)
1/4" I.D., 5/8" O.D., 2 FABRIC BRAID					
622201-3	1/4" NPTM x 1/4" NPTM	Buna N	Neoprene	3' (.9)	250 (17)
622201-5	1/4" NPTM x 1/4" NPTM	Buna N	Neoprene	5' (1.5)	250 (17)
622201-25	1/4" NPTM x 1/4" NPTM	Buna N	Neoprene	25' (7.6)	250 (17)
622204-5	1/4" NPTM x 1/4" NPTSM (FSN)	Buna N	Neoprene	5' (1.5)	250 (17)
622204-25	1/4" NPTM x 1/4" NPTSM (FSN)	Buna N	Neoprene	25' (7.6)	250 (17)
3/4" I.D., 1-3/16" O.D., 2 FABRIC BRAID					
622651-1-F	3/4" NPTM x 3/4" NPTM	Neoprene	Neoprene	1.5' (.4)	600 (41)



622201-5

Low-Pressure Fluid Hoses

Part Number	Fitting Thread Size	Hose Materials Tube	Cover	Lengths ft (m)	psi (bar)
1/2" I.D., 11/16" O.D., 2 FABRIC WIRE BRAID					
622581-6	1/2" NPTM x 1/2" NPTM	Thiokol	Neoprene	6' (1.8)	200 (14)
3/4" I.D., 1-1/4" O.D., 2 FABRIC BRAID					
622681-6	3/4" NPTM x 3/4" NPTM	Thiokol	Neoprene	6' (1.8)	200 (14)

Medium-Pressure Fluid Hoses

Part Number	Fitting Thread Size	Hose Materials Tube	Cover	Lengths ft (m)	psi (bar)
1/4" I.D., 1/2" O.D., CONDUCTIVE POLYMER					
628042-25	1/4" NPSM(FSN) x 1/4" NPSM(FSN)	Nylon	Nylon	25' (7.6)	3000 (207)

High-pressure Hose

Model	ID in (mm)	OD in (mm)	Fitting threads both ends in (mm)	Max pressure psi (bar)	Length ft (m)
BUNA-N TUBE, NEOPRENE COVER					
1-WIRE BRAID					
623501-2	1/2" (12.7)	29/32" (23.0)	1/2" (12.7) NPT (M)	2,000 (138)	2' (0.6)
623501-5	1/2" (12.7)	29/32" (23.0)	1/2" (12.7) NPT (M)	2,000 (138)	5' (1.5)
623501-6	1/2" (12.7)	29/32" (23.0)	1/2" (12.7) NPT (M)	2,000 (138)	6' (1.8)
623501-8	1/2" (12.7)	29/32" (23.0)	1/2" (12.7) NPT (M)	2,000 (138)	8' (2.4)
2-WIRE BRAID					
624201-2	1/4" (6.3)	11/16" (17.5)	1/8" (3.2) NPT (F)	5,000 (345)	2' (0.6)
624201-6	1/4" (6.3)	11/16" (17.5)	1/8" (3.2) NPT (F)	5,000 (345)	6' (1.8)
624201-10	1/4" (6.3)	11/16" (17.5)	1/8" (3.2) NPT (F)	5,000 (345)	10' (3)
624201-30	1/4" (6.3)	11/16" (17.5)	1/8" (3.2) NPT (F)	5,000 (345)	30' (9.1)
624401-4	3/8" (9.5)	27/32" (21.4)	3/8" (9.5) NPT (M)	4,000 (276)	4' (1.2)
624401-8	3/8" (9.5)	27/32" (21.4)	3/8" (9.5) NPT (M)	4,000 (276)	8' (2.4)
624601-4	3/4" (19.1)	1-1/4" (31.7)	3/4" (19.1) NPT (M)	2,250 (155)	4' (1.2)
ELASTOMER TUBE, POLYESTER COVER					
1-WIRE BRAID					
628067-3	1" (25.4)	1-1/4" (31.7)	1" (25.4) NPT (M)	800 (55)	3' (0.9)

In selecting a hose, be sure the hose material is compatible with the fluid being pumped and that the maximum working pressure will not be exceeded in the application. Only those hose length options listed with each model are available. Substitute -XX with -5, -15, -25, etc., to indicate length selection. (Example: Substitute -XX with length selection, such as -50.)

If length is single digit, use that digit only. Do not add zeros.)

*CAUTION: These hoses cannot be used with 100:1 ratio pumps.

Never use a hose with a maximum pressure rating lower than the highest pressure the pump can generate.

Siphon Hoses

Part Number	Description
65986-1	SIPHON HOSE
Features	<ul style="list-style-type: none"> • 55-gallon size; neoprene cover and thiokol tube • Includes 91020-2 pipe extension
Used With	• 651852 drum cover or closed drum with 2" bung opening
Hose	• 6' length, 3/4" (M) fluid outlet
622702-6	SIPHON HOSE
Features	• 1" I.D. hose with stainless steel fittings
Used With	• Stainless steel stub pumps
Hose	• 6' length, 1" (M) fluid outlet, 1" (M) fluid inlet
622701-6	SIPHON HOSE
Features	• 1" I.D. hose with carbon steel fittings
Used With	• Carbon steel stub pumps
Hose	• 6' length, 1" (M) fluid outlet, 1" (M) fluid inlet
67140-1	STAINLESS STEEL SIPHON HOSE
Features	• For 5-gallon containers; includes 16" wand and 5' of 3/4" I.D. hose
Used With	• Wall-mounted Integrity pumps
Hose	• 5' length, 3/4" (M) fluid outlet
67140-2	STAINLESS STEEL SIPHON HOSE
Features	• For 55-gallon containers; includes 36" wand and 5' of 3/4" I.D. hose
Used With	• Wall-mounted Integrity pumps
Hose	• 5' length, 3/4" (M) fluid outlet



67140-1



65986



ARO-Stop

Over-Run Controls

Part Number	Description
635040	ARO-STOP VALVE
Features	<ul style="list-style-type: none"> • Shuts off air to the pump when material container is empty or line is broken • Quick set and reset feature
Used With	• 2" and N-Series air motor pumps
Air Inlet/Outlet	• 1/4" NPT(F) inlet/1/4" NPT(M) outlet
Pressure Range	• 20 – 175 psi (1.4 – 12 bar)
Flow	• 21 cfm @ 100 psi
23644-400	ARO-STOP VALVE
Features	<ul style="list-style-type: none"> • Shuts off air to the pump when material container is empty or line is broken • Quick set and reset feature
Used With	• 4-1/4" and 6" air motor pumps
Air Inlet/Outlet	• 1/2" NPT(F) inlet/1/2" NPT(M) outlet
Pressure Range	• 20 – 175 psi (1.4 – 12 bar)
Flow	• 80 cfm @ 100 psi
635043	ARO-STOP VALVE
Features	<ul style="list-style-type: none"> • Shuts off air to the pump when material container is empty or line is broken • Quick set and reset feature
Used With	• 8", 10", and 12" air motor pumps
Air Inlet/Outlet	• 3/4" NPT(F) inlet/3/4" NPT(M) outlet
Pressure Range	• 20 – 175 psi (1.4 – 12 bar)
Flow	• 135 cfm @ 100 psi



635040

Agitators

Part Number	Container Size gal	Drum Cover	Air Motor Number	hp (kW)	Motor rpm	Mount	Diameter in (mm)	Length in (mm)	Rod Model	Material
651100	5	651851 drum cover	650252	1/3 (.25)	500 – 1,000	Hub	1/2" (12.7)	12" (305)	92094-4	416 stainless steel
651104-3	5	drum cover	650250	3/4 (.36)	300 – 3,000	Flange	1/2" (12.7)	10.5" (267)	92094-3	316SS stainless steel
60307-1	55	61729, 66197 drum cover	650250	3/4 (.56)	300 – 3,000	Flange	1/2" (12.7)	32" (813)	73120	Carbon steel
651103	55	Drum side mount	650250	3/4 (.56)	300 – 3,000	Flange	1/2" (12.7)	32" (813)	92094-1	316 stainless steel
651104-1	55	66197 drum cover	650250	3/4 (.56)	300 – 3,000	Flange	1/2" (12.7)	32" (813)	92094-1	316SS stainless steel

Propeller Specifications

Part Number	Number of Props	Diameter in (mm)	Prop Number	Material	Prop Direction
651100	1	4" (102)	94783-1	316 stainless steel	CCW
651104-3	1	5" (127)	94783-1	316 stainless steel	CCW
60307-1	2	5" (127)	73121, 73122	316 stainless steel	CCW
651103	2	5" (127)	94783-1	316 stainless steel	CCW
651104-1	2	5" (127)	94783-1	316 stainless steel	CCW



651100



651103



651104-3



651104-1

Inlet Accessories/Adapters

Part Number	Description
651830	SCREEN ASSEMBLY
Features	<ul style="list-style-type: none"> Adapts to 91020-1 or 91020-2 pipe extension keeps foreign matter from entering lower pump end
94254	INLET ADAPTER
Features	<ul style="list-style-type: none"> 90° 1" NPT(M) x 3/4" (F) used to adapt suction hose to 67139 cart
Used With	<ul style="list-style-type: none"> Integrity pumps
94256	OUTLET REDUCING ADAPTER
Features	<ul style="list-style-type: none"> For mounting material filter 1" NPT(M) x 1/2" NPT(M)
Used With	<ul style="list-style-type: none"> Integrity 2-ball pumps



94254



94256

Pressure Relief Valve / Valve Kit

Model	Description
PRESSURE RELIEF VALVE / VALVE KITS	
61117	Pressure relief valve is used on material outlet side of pump to automatically allow bleed-back of material to container in applications where thermal expansion is present.
61118	Pressure relief valve kit includes 61117 relief valve, reducing bushing, compression coupling, 3' (0.9 m) of plastic drain tubing, and grommet (for drum attachment)

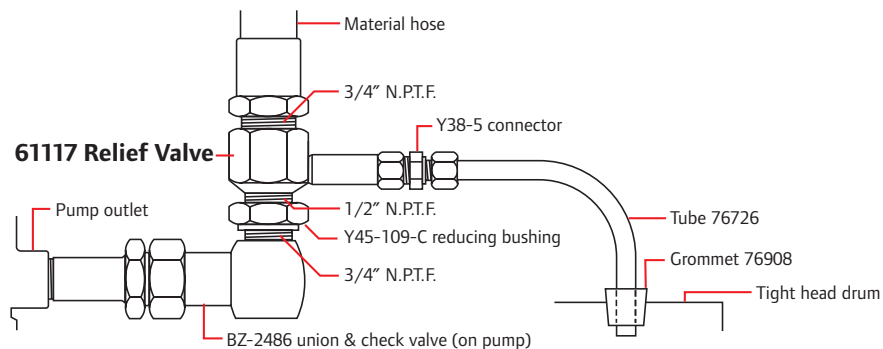

Mufflers

Air Motor Mufflers

Air Motor Muffler Kits

Model	Inlet Pressure**	Cycle Rate**	Used With	Equivalent Continuous Level (dBA)
67445-1	60 psig	40 cpm	AF044X-XX	80.8
			AF046X-XX	77.8
67445-2			AF064X-XX	79.8
			AF066X-XX	82
67445-3			AF08XX-XX	81.8
67445-4			AF10XX-XX	83.7
67445-5			AF12XX-XX	86.9

*The pump sound pressure level has been updated to an Equivalent Continuous Sound Level (L_{aeq}) to meet the intent of ANSI S1.13-1971, CAGI-PNEUROPS.1 using 4 microphone locations.

**Inlet Pressure - 60 psig, Cycle Rate - 40 cpm



67445-X

Valves

Ball Valve Regulators

Model	Air Inlet Port	Maximum Air Inlet Pressure	Operating Temperature Range	Maximum Air Flow	Used With (Air Motor Part No.)
67442	1/2" 14NPT	Refer to Air Inlet PMAX found on model plate of pump/ air motor	23 F to 1750 F (-50 C to 790 C)	SCFM (101 dm ³ /s)	AF04XX-01, AF06XX-01, AF08XX-01, AF10XX-01, AF12XX-01



67442

Swivels

Z and Straight Swivels

Model	Thread Size NPT x NPT in	Type of Seals	Max Working Pressure psi (bar)
STRAIGHT SWIVEL			
636075	1/8" (M) x 1/8" (F)	Fabric with neoprene	10,000 (689.4)
636085	3/8" (M) x 3/8" (F)	Fabric with neoprene	10,000 (689.4)
635107	3/8" (M) x 1/2" (F)	Fabric with neoprene	2,000 (137.8)
635117	1/2" (M) x 1/2" (F)	Fabric with neoprene	2,000 (137.8)
635108	3/4" (M) x 3/4" (F)	Fabric with neoprene	1,000 (68.9)
Z 360° SWIVEL			
636077	1/8" (M) x 1/8" (F)	Fabric with neoprene	10,000 (689.4)
636083	1/8" (F) x 3/8" (F)	Fabric with neoprene	10,000 (689.4)
636084	1/8" (F) x 1/4" (F)	Fabric with neoprene	10,000 (689.4)
636086-B	1/4" (F) x 1/4" (M)	Fabric with neoprene	6,700 (461.8)
636087-B	1/4" (F) x 1/4" (M)	Fabric with neoprene	6,700 (461.8)
		Includes 67176-5 edge-type filter element	
636088	3/8" (M) x 3/8" (F)	Fabric with neoprene	10,000 (689.4)
635106	1/2" (F) x 3/8" (M)	Fabric with neoprene	10,000 (689.4)



636075



635108



636077

Valves

Fluid Control Valve

Model	Inlet outlet NPT in (mm)	Body material	Seat material	Max working pressure psi (bar)
BALL VALVES				
USED TO CONTROL THE ON-OFF FLOW OF FLUID MATERIAL OR AIR. SELECT PROPER WORKING PRESSURE AND MATERIAL COMPATIBILITY FOR APPLICATION.				
61124	3/4" (19.1) (F)	Bronze	Buna-N	200 (14)
66592	1/2" (12.7) (F)	Carbon steel	PTFE	2,000 (138)
66593	3/8" (9.5) NPS (M) x 3/8" (9.5) (M)	303 stainless steel	PTFE	4,000 (276)
PLUG VALVES				
Y28-1	1/4" (6.3) (F)	Brass	N/A	150 (10)
Y28-2	1/8" (3.2) (F)	Brass	N/A	150 (10)
NEEDLE VALVES				
92818	1/4" (6.3) (F) x 1/4" (6.3) (M)	Brass	Leather	125 (9)
GLOBE VALVES				
Y26-1	3/4" (19.1) (F)	Brass	Graphite	125 (9)
BALL VALVES				
104077-2	1/4" (6.3) (F)	Nickel-plated brass	PTFE	225 (16)
104077-3	3/8" (9.5) (F)	Nickel-plated brass	PTFE	225 (16)
104077-4	1/2" (12.7) (F)	Nickel-plated brass	PTFE	225 (16)



Fittings

Grease Gun Couplers

Button Head Coupler

636020 - Standard button coupler. Can be converted to either push-on or pull-on.

636024 - Standard button coupler. Can be converted to either push-on or pull-on.

Model	Inlet thread connection in (mm)	Length in (mm)	Max working pressure psi (bar)
636020	7/16"-27 (11.1) (F)	-	8,000 (552)
636024	1/8" (3.2) NPT (F)	-	8,000 (552)
636027	1/8" (3.2) NPT (F)	1-5/8" (41)	6,000 (414)
636028	1/8" (3.2) NPT (F)	1-5/8" (41)	10,000 (689)
636046	1/8" (3.2) NPT (F)	1-7/16" (37)	6,000 (414)



Standard Hydraulic Couplers

636027 - Small-diameter hydraulic coupler.

636028 - Reversible jaw hydraulic coupler.

636046 - Small-diameter hydraulic coupler with ball check.

Model	Thread size NPT in (mm)	Material of construction
STRAIGHT COUPLINGS — 150 PSI (10 BAR) MAX		
6,750 PSI (446 BAR) MAX		
77617	3/8" (9.5) (M) x 1/2" (12.7) (M)	Zinc-plated steel
5,000 PSI (345 BAR) MAX		
76751	1/4" (6.3) (M) x 11/16"-16 (17.5) (M)	Steel
8,000 PSI (552 BAR) MAX		
2722	1/8" (3.2) (M) x 11/16"-16" (17.5) (M)	Steel
73581	1/4" (6.3) (M) x 3/8" (9.5) (M)	Steel
76493	1/8" (3.2) (M) x 3/8" (9.5) (M)	Steel
REDUCING BUSHINGS — 150 PSI (10 BAR) MAX		
Y45-5-C	1/4" (6.3) (F) x 1/2" (12.7) (M)	Iron
Y45-9-C	1/2" (12.7) (F) x 3/4" (19.1) (M)	Iron
3,000 PSI (207 BAR) MAX		
Y45-105-C	1/4" (6.3) (F) x 1/2" (12.7) (M)	Steel
Y45-106-C	3/8" (9.5) (F) x 1/2" (12.7) (M)	Steel
Y45-109-C	1/2" (12.7) (F) x 3/4" (19.1) (M)	Steel
10,000 PSI (690 BAR) MAX		
6788	1/4" (6.3) (F) x 1/2" (12.7) (M)	Steel
STREET ELBOWS — 150 PSI (10 BAR) MAX		
Y43-1-C	1/8" (3.2) (M) x 1/8" (3.2) (F)	Iron
Y43-2-C	1/4" (6.3) (M) x 1/4" (6.3) (F)	Iron
Y43-4-C	1/2" (12.7) (M) x 1/2" (12.7) (F)	Iron
Y43-5-C	3/4" (19.1) (M) x 3/4" (19.1) (F)	Iron
Y43-6-C	1" (25.4) (M) x 1" (25.4) (F) plated	Iron
STRAIGHT COUPLINGS — 150 PSI (10 BAR) MAX		
Y43-44	1/2" (12.7) (F) x 1/2" (12.7) (F)	Iron
Y43-48-C	1-1/2" (38.1) (F) x 1-1/2" (38.1) (F)	Iron
SHORT NIPPLES — 150 PSI (10 BAR) MAX		
Y27-2-C	1/4" (6.3) (M) x 1/4" (6.3) (M)	Plated iron
Y27-52-C	1/4" (6.3) (M) x 1/4" (6.3) (M)	Plated iron
Y27-54-C	1/2" (12.7) (M) x 1/2" (12.7) (M)	Plated iron
Y27-55-C	3/4" (19.1) (M) x 3/4" (19.1) (M)	Plated iron
Y27-56-C	1" (25.4) (M) x 1" (25.4) (M)	Plated iron
8,000 PSI (552 BAR) MAX		
676	1/8" (3.2) (M) x 1/8" (3.2) (M)	Steel
1950	1/4" (6.3) (M) x 1/4" (6.3) (M)	Steel
LONG NIPPLES — 150 PSI (10 BAR) MAX		
LENGTH — 2" (51 MM)		
Y44-11-C	1/4" (6.3)	Plated iron
LENGTH — 2-1/2" (63.5 MM)		
Y44-12-C	1/4" (6.3)	Plated iron
ELBOWS — 150 PSI (10 BAR) MAX		
Y43-15-C	3/4" (19.1) (F) x 3/4" (19.1) (F)	Iron
3,000 PSI (207 BAR) MAX		
Y43-215	3/4" (19.1) (F) x 3/4" (19.1) (F)	Steel



77617



Y45-106-C



Y43-2-C



Y43-44



676

Fittings (continued)

Model	Thread size NPT in (mm)	Material of construction	Max pressure psi (bar)
SWIVEL UNIONS			
75364	1/4" (6.3) (M) x 1/4" (6.3) (F)	Steel	10,000 (690)
75366	1/2" (12.7) (M) x 1/2" (12.7) (F)	Steel	6,750 (466)
75367	3/4" (19.1) (M) x 3/4" (19.1) (F)	Steel	4,375 (302)
75368	1" (25.4) (M) x 1" (25.4) (F)	Steel	3,550 (245)
75369	1/4" (6.3) (F) x 1/4" (6.3) (F)	Steel	10,000 (690)
PLAIN TEE – FEMALE			
Y43-32-C	1/4" (6.3) x 1/4" (6.3) x 1/4" (6.3)	Iron	150 (10)
Y43-233-C	3/8" (9.5) x 3/8" (9.5) x 3/8" (9.5)	Steel	3,000 (207)
PIPE PLUGS – MALE			
Y17-50	1/8" (3.2) countersunk (hex)	Steel	10,000 (690)
Y17-51	1/4" (6.3) countersunk (hex)	Steel	10,000 (690)
FEMALE ADAPTER			
4280	3/8" (9.5) (F) x 1/8" (3.2) NPT (F)	Steel	8,000 (552)
ADAPTER UNIONS			
Y167-3	1/2" (12.7) (F) x 3/8" (9.5) NPT (M)	Steel	6,000 (414)
Y167-4	3/4" (19.1) (F) x 1/2" (12.7) NPT (M)	Steel	5,000 (345)
Y167-5	1/2" (12.7) (F) x 1/4" (6.3) NPT (M)	Steel	6,000 (414)
4295	1/8" (3.2) PTF SAE short (F) x 7/16"-27 (11.1) (M)	Steel	8,000 (552)
4616	1/2" (12.7) (F) x 1-3/8"-18 (34.9) (M)	Steel	8,000 (552)



75364



Y43-233-C

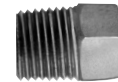

Y17-10

Fluid Couplers

Model	Description
92021	Quick connect fluid coupler (female) — 3/4" (19.1) NPT (F) couples with 92022 fluid connector



92021

WARNING: To ensure safe operation, be sure the maximum working pressure of your fluid handling system does not exceed the maximum working pressure of the fittings.

Fluid Ball Check Unions

Model	Body material	Ball material	Seat material	Inlet NPT in (mm)	Outlet NPT in (mm)	Max working pressure psi (bar)
66559	Carbon steel	440C stainless steel	440 F stainless steel	1" (25.4) (M)	1" (25.4) (F)	8,000 (552)

 <p>1/8" and 1/4" Ports Max Inlet Press: Poly bowl 150 psi Metal bowl 250 psi Series size: Miniature</p>	 <p>1/4" and 3/8" Ports Max Inlet Press: Poly bowl 150 psi Metal bowl 250 psi Series size: Compact</p>	 <p>3/8", 1/2" and 3/4" Ports Max Inlet Press: Poly bowl 150 psi Metal bowl 250 psi Series size: Standard</p>	 <p>3/4" and 1" Ports Max Inlet Press: Metal bowl 250 psi Series size: Heavy Duty</p>	 <p>1", 1-1/4", 1-1/2", 2" and 3" Ports Max Inlet Press: Filter Metal bowl 300 psi Lubricator Metal bowl 200 psi Series size: Super Duty</p>
---	---	---	--	--

- ▶ **SAFETY:** Designed with locking bowls and clear multilingual markings
- ▶ **BEST-IN-CLASS AIR FLOW PERFORMANCE:**
 38% better than the competition
- ▶ **MODULARITY:** All ARO-Flo products are designed to integrate with each other
- ▶ **QUICK ASSEMBLY:** Can be easily, safely and quickly assembled or disassembled with a minimum of tools – no fuss or complications

	1/8" Port Size	1/4" Port Size	3/8" Port Size	1/2" Port Size	3/4" Port Size	1" Port Size	1-1/2" Port Size	2" Port Size
1000 Series	46 scfm*							
1500 Series		85 scfm*						
2000 Series			150 scfm*					
3000 Series					215 scfm*			
Super Duty Series						1200 scfm		
Specialty Regulators	Precision, Stainless Steel and Brass Regulators							

* Flow rates based off of Filter/Regulator/Lubricator combination unit. Individual units flow rates are higher.



- | | |
|---------------------------------|------------------------------|
| 1 Modular Pipe Adapter | 7 Regulator |
| 2 T-Brackets | 8 ARO-Flo Check Valve |
| 3 Modular Spacers | 9 Manifold Port Block |
| 4 Modular Lock-Out Valve | 10 Pressure Switch |
| 5 Soft-Start Valve | 11 Lubricator |
| 6 Filter w/indicator | |



Ingersoll Rand attests that ARO-Flo Series of filters, regulators, lubricators (1000, 1500, 2000, 3000 Series) and select accessories are out of scope for ATEX Directive 94/9/EEC or 2014/34/EU. The products listed in IRITS-1215-197 certificate can be used in group II, category 2 environment; Gas and Dust with temperature a T6 (Ex II 2GD T6) if all conditions set up in the Instruction Manual are met. Instruction Manuals and certificate regarding ATEX Declaration can be found at AROZONE.COM

► Piston Pump Selection Guide *(Most popular)*

Pump Motor Size	Filter Metal Bowl w/Sight Glass	Regulator	Piggyback, Poly Bowl w/Guard	Piggyback, Poly Bowl w/Guard, Auto Drain	Piggyback, Metal Bowl w/Sight Glass	Piggyback, Metal w/ Sight Glass, Auto Drain	FRL Combo (3 Piece) Metal Bowl w/Sight Glass	F/R-L Combo (2 Piece) Metal Bowl w/Sight Glass	FRL Port Size
2"	F35221-410	R37221-600	<i>P39224-600</i>	<i>P39224-604</i>	<i>P39224-610</i>	P39224-614	C38221-810	<i>C38221-610</i>	1/4" NPT
3"	F35221-410	R37221-600	<i>P39224-600</i>	<i>P39224-604</i>	<i>P39224-610</i>	P39224-614	C38221-810	<i>C38221-610</i>	1/4" NPT
4.25"	F35341-410	R37341-600	<i>P39344-600</i>	<i>P39344-604</i>	<i>P39344-610</i>	P39344-614	C38341-810	<i>C38341-610</i>	1/2" NPT
6"	F35341-410	R37341-600	<i>P39344-600</i>	<i>P39344-604</i>	<i>P39344-610</i>	P39344-614	C38341-810	<i>C38341-610</i>	1/2" NPT
8"	F35351-410	R37351-600	<i>P39354-600</i>	<i>P39354-604</i>	<i>P39354-610</i>	P39354-614	C38351-810	<i>C38351-610</i>	3/4" NPT
10"	F35451-410	R37451-600			<i>P39454-610</i>	P39454-614	C38451-810	<i>C38451-610</i>	3/4" NPT
12"	F35451-410	R37451-600			<i>P39454-610</i>	P39454-614	C38451-810	<i>C38451-610</i>	3/4" NPT
2"	F352B1-410	R372B1-600	<i>P392B4-600</i>	<i>P392B4-604</i>	<i>P392B4-610</i>	P392B4-614	C382B1-810	<i>C382B1-610</i>	1/4" BSP
3"	F352B1-410	R372B1-600	<i>P392B4-600</i>	<i>P392B4-604</i>	<i>P392B4-610</i>	P392B4-614	C382B1-810	<i>C382B1-610</i>	1/4" BSP
4.25"	F353D1-410	R373D1-600	<i>P393D4-600</i>	<i>P393D4-604</i>	<i>P393D4-610</i>	P393D4-614	C383D1-810	<i>C383D1-610</i>	1/2" BSP
6"	F353D1-410	R373D1-600	<i>P393D4-600</i>	<i>P393D4-604</i>	<i>P393D4-610</i>	P393D4-614	C383D1-810	<i>C383D1-610</i>	1/2" BSP
8"	F353E1-410	R373E1-600	<i>P393E4-600</i>	<i>P393E4-604</i>	<i>P393E4-610</i>	P393E4-614	C383E1-810	<i>C383E1-610</i>	3/4" BSP
10"	F354E1-410	R374E1-600			<i>P394E4-610</i>	P394E4-614	C384E1-810	<i>C384E1-610</i>	3/4" BSP
12"	F354E1-410	R374E1-600			<i>P394E4-610</i>	P394E4-614	C384E1-810	<i>C384E1-610</i>	3/4" BSP

► Diaphragm Pump Selection Guide *(Most popular)*

Pump Size	Coalescing Filter Metal Bowl w/Sight Glass	Regulator	Piggyback, Poly Bowl w/Guard	Piggyback, Poly Bowl w/Guard, Auto Drain	Piggyback, Metal Bowl w/Sight Glass	Piggyback Metal Bowl w/Sight Glass, Auto Drain	FRL Combo (3 Piece) Metal Bowl w/Sight Glass	FRL Combo (2 Piece) Metal Bowl w/Sight Glass	FRL Port Size
1/4", 3/8", 1/2", 3/4"	F35121-320	R37121-600	<i>P39124-600</i>	<i>P39124-604</i>	<i>P39124-620</i>	P39124-624	C38121-820	C38121-620	1/4" NPT
1"	F35221-310	R37221-600	<i>P39224-600</i>	<i>P39224-604</i>	<i>P39224-610</i>	P39224-614	C38221-810	C38221-610	1/4" NPT
3:1 Ratio	F35341-310	R37341-600	<i>P39344-600</i>	<i>P39344-604</i>	<i>P39344-610</i>	P39344-614	C38341-810	C38341-610	1/2" NPT
1-1/2"	F35341-310	R37341-600	<i>P39344-600</i>	<i>P39344-604</i>	<i>P39344-610</i>	P39344-614	C38341-810	C38341-610	1/2" NPT
2"	F35351-310	R37351-600	<i>P39354-600</i>	<i>P39354-604</i>	<i>P39354-610</i>	P39354-614	C38351-810	C38351-610	3/4" NPT
3"	F35451-410	R37451-600			<i>P39454-610</i>	P39454-614	P39454-611	C38451-810	3/4" NPT
1/4", 3/8", 1/2", 3/4"	F351B1-420	R371B1-600	<i>P391B4-600</i>	<i>P391B4-604</i>	<i>P391B4-620</i>	P391B4-624	C381B1-820	C381B1-620	1/4" BSP
1"	F352B1-410	R372B1-600	<i>P392B4-600</i>	<i>P392B4-604</i>	<i>P392B4-610</i>	P392B4-614	C382B1-810	C382B1-610	1/4" BSP
3:1 Ratio	F353D1-410	R373D1-600	<i>P393D4-600</i>	<i>P393D4-604</i>	<i>P393D4-610</i>	P393D4-614	C383D1-810	C383D1-610	1/2" BSP
1-1/2"	F353D1-410	R373D1-600	<i>P393D4-600</i>	<i>P393D4-604</i>	<i>P393D4-610</i>	P393D4-614	C383D1-810	C383D1-610	1/2" BSP
2"	F353E1-410	R373E1-600	<i>P393E4-600</i>	<i>P393E4-604</i>	<i>P393E4-610</i>	P393E4-614	C383E1-810	C383E1-610	3/4" BSP
3"	F354E1-410	R374E1-600			<i>P394E4-610</i>	P394E4-614	P394E4-611	C384E1-810	3/4" BSP

Distributed by:

www.AROzone.com

arotechsupport@irco.com

youtube.com/aropumps

(800) 495-0276

ARO®

ARO® is a brand of Ingersoll Rand. Ingersoll Rand (NYSE:IR) advances the quality of life by creating comfortable, sustainable and efficient environments. Our people and our family of brands—including Club Car®, Ingersoll Rand®, Thermo King® and Trane®—work together to enhance the quality and comfort of air in homes and buildings; transport and protect food and perishables; and increase industrial productivity and efficiency. We are a \$14 billion global business committed to a world of sustainable progress and enduring results. For more information, visit www.ingersollrand.com.